



# SM3300 - series

- **SM18-220**
- **SM66-AR-110**
- **SM100-AR-75**
- **SM330-AR-22**
- **SM660-AR-11**

## **Firmware Update**

It is strongly recommended, first to perform a firmware update before further operation. Download the SM3300 Quick Start Manual for instructions.

## **Driver & Example Software**

For several applications and Interfaces there is Driver & Example Software available on our website. See [PRODUCTS\SM3300\DOWNLOADS](#).

## **PRODUCT MANUAL**

### **Firmware version P0157**

Contents:

- 1 – **Safety Instructions**
- 2 – **Sicherheitshinweise**
- 3 – **Consignes de Sécurité**
- 4 – **Quick Start**
- 5 – **General**
- 6 – **Installation**
- 7 – **Front Menu Operation**
- 8 – **Remote Programming**
- 9 – **Trouble Shooting**
- 10 – **Maintenance & Calibration**
- 11 – **EU Declaration of Conformity**

# 1 SAFETY INSTRUCTIONS – SM3300-series

## 1.1 Caution

The following safety precautions must be observed during all phases of operation, service and repair of this equipment. Failure to comply with the safety precautions or warnings in this document violates safety standards of design, manufacture and intended use of this equipment and may impair the built-in protections. Delta Elektronika shall not be liable for user's failure to comply with these requirements.

## 1.2 Installation Category

The Delta Elektronika power supplies have been evaluated to installation category II (Over voltage category II).

## 1.3 Grounding of Mains Terminals (AC Power Terminals)

This product is a safety Class 1 unit. To minimize shock hazard, the unit must be connected to the AC Power Supply mains through a three or four conductor power cable for respectively a single or three phase unit, with the ground wire firmly connected to an electrical ground (safety ground) at the power outlet.

For units designed to be hard-wired to the mains supply, the protective earth terminal must be connected to the safety electrical ground before another connection is made. Any interruption of the protective ground conductor, or disconnection of the protective earth terminal will cause a potential shock hazard that might cause personal injury.

## 1.4 Grounding of DC Power Terminals

If the DC power terminal of a unit is specified to sink or source to a maximum of 60VDC, and either the 'minus' or 'plus' DC power terminal is grounded, the voltage on the DC power terminals and sense connections can be considered safe.

**Warning!** When the 'plus' DC power terminal can exceed 60VDC in respect to the 'minus' DC power terminal, additional external measures must be taken to ensure safety isolation of the DC power terminals and sense connections.

**Warning!** When the 'minus' DC power terminal of the unit can exceed 60VDC / 42.4Vpk in respect to ground, additional external measures must be taken to ensure safety isolation of the DC power terminals and sense connections.

The standard LAN, USB and Interlock connectors and optional interfaces are at ground level and can be considered safe if the 'minus' DC power terminal of the unit does not exceed 1000VDC / 707Vpk in respect to ground.

**Caution 1:** If a low voltage unit has both DC power terminals floating, or if the terminals are in series with an external high AC or DC voltage, the 'minus' DC power terminal can exceed the safe value in respect to ground as specified in the above warning!

**Caution 2:** Although a high voltage unit is set to a safe voltage below 60VDC, for safety it must always be considered as a high voltage unit! Wrong operation, a programming error or an external defect can result in an unsafe high DC output voltage.

For more information regards Grounding & Safety, see online application note "*Safe operation of a power supply*".

## 1.5 Danger of electrical shock

Touching the contacts of the mains plug or wires directly after disconnecting from the mains, can cause an electrical shock. And there can still be a dangerous voltage between one of the DC power terminals and the PE because of charged X-capacitors. This can also happen when the DC power output is switched off, but the unit is still switched on! Therefore never touch PE and one of the DC power terminals at the same time.

## 1.6 Connection to mains supply

Either connect to the mains supply permanently or via an industrial type plug, complying with IEC 60309. "Permanently connected equipment" or "Pluggable equipment type B".

## 1.7 Fuses

Fuses to be changed by authorized Delta Elektronika service personnel only, for continued protection against risk of fire.

## 1.8 AC Input Ratings

Do not use an AC Supply which exceeds the AC input voltage and frequency rating of this unit. The AC input voltage and frequency rating of the Delta Elektronika power supply series are stated in the accompanying datasheet.

## 1.9 Live Circuits

Operating personnel should not remove the unit covers. No internal adjustment or component replacement is allowed by non Delta Elektronika qualified personnel. Never replace components with the power cable connected. To avoid injuries, always disconnect power, remove external voltage sources and discharge circuits before touching components.

## 1.10 Parts Substitutions & Modifications

Parts substitutions and modifications are allowed by authorized Delta Elektronika service personnel only. For repairs the unit must be returned to a Delta Elektronika service facility.

## 1.11 Removal of (safety) covers

Safety cover(s) are used to cover potentially hazardous voltages. Observe the following when removing safety cover(s):

- Switch off the unit and disconnect the unit from the AC mains supply and from the DC power application.
- Wait for 5 minutes to allow internal capacitors to discharge, then unscrew and remove the cover(s).
- Always place the cover(s) back before connecting the unit to the mains supply again.

### 1.12 Handling and mounting

**Warning!** Unit weight is 15kg! Take care when unpacking or moving unit: lift with 2 persons or use a lift tool.

- Risk of crushing or clamping of limbs!
- Risk of cutting: unit has sharp edges and corners!

**Warning!** No wall mounting or ceiling mounting allowed! Risk of crushing under unit. Only mount unit horizontally, place on a stable surface or use rack mounting.

### 1.13 Rotating fan, thermal burn

Proper air flow is required for cooling of the unit. This enables operation at full power and a longer lifetime. If the unit gets over heated, the power will shut down until unit has cooled down again.

**Warning!** Top cover and fan exhausts can get hot. Avoid touching these while operating the unit at high power!

**Warning!** Do not block fan openings, or air exhausts. Do not try to enter fan openings by any object to obstruct fan. Long hair can get stuck in fan, wear a hairnet if you have long hair.

**Warning!** Do not (dis)connect cables to the DC power terminals while the unit is on. Sudden making or breaking of high DC currents can cause large sparks, even at low voltages. Risk of thermal burn and fire!

### 1.14 Electro medical devices

**Warning!** High currents can run through the DC power terminals. These currents cause strong magnetic fields. Do not come near if you have an electro medical device such as a pacemaker.

### 1.15 Environmental Conditions

- The Delta Elektronika power supplies safety approval applies to the following operating conditions:

- Usage : Indoor use only.  
**Warning!** Not intended to be used in the presence of children or animals!
- Ambient temperature : -20 to 50 °C.
- Maximum relative humidity : 95%, non-condensing, up to 40 °C, 75%, non-condensing, up to 50 °C.
- Altitude : Do not use above 2000 m sea level.  
**Warning!** Electrical Creepage & Clearance not valid for higher altitudes!
- Pollution degree : 2

### 1.16 Symbols & markings



Caution risk of electrical Shock.



Instruction manual symbol. The instrument will be marked with this symbol when it is necessary for the user to refer to the instruction manual.



Protective ground conductor terminal.



Off (supply).



On (supply).

### 1.17 Canada



This product has been tested to the requirements of CAN/CSA-C22.2 No. 61010.1, second edition, including Amendment 1, or a later version of the same standard incorporating the same level of testing requirements.

### 1.18 cTUVus



## WEEE (Waste Electrical & Electronic Equipment)

### 1.19 Correct Disposal of this Product

Applicable in the European Union.



This marking shown on the product, its packing or its literature indicates that it should not be disposed with other wastes at the end of its working life but should be collected separately to recycle it responsibly to promote the sustainable reuse of material resources.

## 2 SICHERHEITSHINWEISE – SM3300-series

### 2.1 Vorsicht

Die folgenden Sicherheitsvorkehrungen müssen in allen Betriebs-, Service- und Reparaturphasen dieses Geräts befolgt werden. Die Nichteinhaltung der Sicherheitsvorkehrungen oder Warnungen in diesem Dokument verstößt gegen die Sicherheitsstandards im Hinblick auf Bauart, Produktion und vorgesehene Nutzung dieses Geräts und kann die eingebauten Schutzvorrichtungen beschädigen. Delta Elektronika haftet nicht dafür, wenn der Nutzer diesen Anforderungen nicht nachkommt.

### 2.2 Installationskategorie

Die Delta Elektronika Stromversorgungen wurden der Installationskategorie II (Überspannungskategorie II) zugeordnet.

### 2.3 Erdung der Netzanschlussklemmen (AC-Einspeiseklemmen)

Dieses Produkt ist ein Gerät der Sicherheitsklasse 1. Um die Gefahr eines elektrischen Schlags zu minimieren, muss das Gerät mit einem Drei- oder Vierleiter-Stromkabel mit dem AC-Stromversorgungsnetz verbunden werden, für eine ein- bzw. dreiphasige Gerät. Hierbei muss der Schutzleiter fest mit einem elektrischen Erdungsanschluss (Schutzleiter) an der Stromquelle verbunden sein. Bei Geräten, die fest mit dem Versorgungsnetz verdrahtet werden, muss die Schutzerdungsklemme mit dem Sicherheitserdungsanschluss verbunden werden, bevor eine andere Verbindung hergestellt wird. Eine Unterbrechung des Schutzleiters oder eine Trennung der Schutzerdungsklemme kann zu einem elektrischen Schlag führen, der zur Verletzung von Personen führen kann.

### 2.4 Erdung der DC-Anschlussklemmen

Wenn die DC-Anschlussklemme eines Geräts dafür ausgelegt ist, maximal 60 VDC zu empfangen oder zu beziehen und entweder die 'minus' oder 'plus' DC-Anschlussklemme geerdet ist, kann die Spannung auf den DC-Anschlussklemmen und Sense-Verbindungen als sicher angesehen werden.

**Warnung!** Wenn die 'plus' DC-Anschlussklemme im Verhältnis zur 'minus' DC-Anschlussklemme 60 VDC überschreiten kann, müssen zusätzliche externe Maßnahmen ergriffen werden, um die Sicherheitsisolation der DC-Anschlussklemmen und Sense-Verbindungen sicherzustellen.

**Warnung!** Wenn die 'minus' DC-Anschlussklemme im Verhältnis zur Erdung 60 VDC/42,4 Vpk überschreiten kann, müssen zusätzliche externe Maßnahmen ergriffen werden, um die Sicherheitsisolation der DC-Anschlussklemmen und Sense-Verbindungen sicherzustellen.

Die standardmäßigen LAN-, USB- und Interlock-Verbinder sowie optionale Schnittstellen sind auf Erdpotential und können als sicher angesehen werden, wenn die 'minus' DC-Anschlussklemme des Geräts im Verhältnis zur Erdung 1000 VDC/707 Vpk nicht überschreitet.

**Vorsicht 1:** Falls beide DC-Anschlussklemmen eines Niederspannungsgerätes potentialfrei sind oder falls die DC-Klemmen in Reihe mit einer externen AC- oder DC-Hochspannung geschaltet sind, kann die 'minus' DC-DC-Anschlussklemme den sicheren Wert in Bezug auf die Erdung wie in der Warnung oben spezifiziert überschreiten.

**Vorsicht 2:** Obwohl ein Hochspannungsgerät mit einer sicheren Spannung unter 60 VDC betrieben wird, muss es zur Sicherheit immer als Hochspannungsgerät angesehen werden! Falsche Bedienung, ein Programmierfehler oder ein externer Fehler können zu einer unsicheren, hohen DC-Ausgangsspannung führen. Für weitere Informationen und Schaltpläne hinsichtlich Erdung und Sicherheit, siehe den online Applikationshinweis 'Safe operation of a power supply'.

### 2.5 Gefahr eines elektrischen Schlags

Das Berühren der Kontakte des Netzsteckers oder der Kabel direkt nach der Trennung vom Netz kann zu einem elektrischen Schlag führen. Und aufgrund von geladenen X-Kondensatoren, kann gefährliches Potential zwischen 'plus' oder 'minus' DC-Anschlussklemme und PE bestehen oder entstehen. Auch wenn die DC-Anschlussklemmen ausgeschaltet sind, aber das Gerät noch eingeschaltet ist. Daher niemals gleichzeitig PE und einen der DC-Anschlussklemmen berühren mit bloßen Händen.

### 2.6 Verbindung mit dem Versorgungsnetz

Entweder permanent mit dem Versorgungsnetz verbinden oder via einer Industriesteckverbindung entsprechend IEC 60309. „Permanent verbundene Ausrüstung“ oder „Steckbare Ausrüstung Typ B“.

### 2.7 Sicherungen

Sicherungen dürfen ausschließlich von autorisiertem Delta Elektronika-Service-Personal ausgetauscht werden, um Brandgefahr dauerhaft auszuschließen.

### 2.8 AC-Eingangsleistung

Verwenden Sie keine AC-Versorgung, welche die AC-Eingangsspannung und Frequenzleistung dieses Geräts überschreitet. Die AC-Eingangsspannung und Frequenzleistung der Delta Elektronika-Stromversorgungsserie sind im beiliegenden Datenblatt angegeben.

### 2.9 Spannungsführenden Stromkreise

Bedienungspersonal darf die Geräteabdeckungen nicht entfernen. Interne Einstellungen oder Bauteilaustausche sind ausschließlich qualifiziertem Personal von Delta Elektronika gestattet. Bauteile nie bei eingestecktem Stromkabel austauschen. Um Verletzungen zu vermeiden, vor dem Berühren von Bauteilen immer den Strom trennen, externe Spannungsquellen entfernen und Stromkreise entladen.

### 2.10 Teileaustausch & Modifikationen

Teileaustausch und Modifikationen sind ausschließlich autorisiertem Delta Elektronika-Service-Personal gestattet. Reparaturen am Gerät dürfen nur durch eine Delta Elektronika-Serviceeinrichtung durchgeführt werden.

## 2.11 Entfernung von (Sicherheits-) Abdeckungen

Sicherheitsabdeckung(en) werden verwendet, um potenziell gefährliche Spannungen abzudecken. Beachten Sie Folgendes, wenn Sie die Sicherheitsabdeckung(en) entfernen:

- Gerät ausschalten, Gerät von dem AC-Versorgungsnetz und DC-Anwendung trennen.
- Warten Sie 5 Minuten um interne Kondensatoren zu entladen. Abschrauben und entfernen von Abdeckung(en).
- Bevor Sie das Gerät wieder mit dem Versorgungsnetz verbinden, montieren Sie vorher jedes Mal die Abdeckung(en).

## 2.12 Handhabung und Montage

**Warnung!** Einheit Gewicht ist 15kg! Beim Auspacken oder Umziehen vorsichtshalber: Heben Sie mit 2 Personen an oder benutzen Sie ein Liftwerkzeug. Gefahr der Zerkleinerung der Gliedmaßen unter Einheit.

Risiko des Schneidens: Einheit hat scharfe Kanten und Ecken!

**Warnung!** Keine Wandmontage oder Deckenmontage erlaubt! Gefahr der Zerkleinerung unter Einheit. Nur Einheit horizontal montieren, auf eine stabile Oberfläche stellen oder Rack-Montage verwenden.

## 2.13 Rotierender Lüfter, thermischer Verbrennung

Für die Kühlung des Geräts ist ein richtiger Luftstrom erforderlich. Dies ermöglicht den Betrieb bei voller Leistung und einer längeren Lebensdauer. Wenn das Gerät überhitzt wird, schaltet sich die Stromversorgung herunter, bis das Gerät wieder abgekühlt ist.

**Warnung!** Top-Abdeckung und Lüfter Auspuffs können heiß werden. Vermeiden Sie diese zu berühren, während Sie das Gerät mit hoher Leistung bedienen!

**Warnung!** Blockieren Sie keine Lüfter Öffnungen oder Luftabsaugungen. Versuchen Sie nicht, Lüfter Öffnungen durch ein Objekt zu betreten, um Lüfter zu behindern. Lange Haare können in Ventilator stecken bleiben, tragen Sie ein Haarnetz, wenn Sie lange Haare haben.

**Warnung!** Schließen Sie keine Kabel an die DC-Anschlussklemmen an, während das Gerät eingeschaltet ist. Plötzliches Machen oder Brechen von hohen Gleichstrom kann große Funken verursachen, auch bei niedriger Spannung. Gefahr von thermischen Verbrennung und Feuer!

## 2.14 Elektromedizinische Geräte

**Warnung!** Hohe Ströme können durch die DC-Anschlussklemmen laufen. Diese Ströme verursachen starke Magnetfelder. Kommen Sie nicht in die Nähe, wenn Sie ein elektromedizinisches Gerät wie einen Herzschrittmacher haben.

## 2.15 Umgebungsbedingungen

Die Stromversorgungssicherheitszulassung von Delta Elektronika gilt für die folgenden Betriebsbedingungen:

- Gebrauch : Nur Innengebrauch. **Warnung!** Nicht für die Verwendung in Gegenwart von Kindern oder Tieren vorgesehen!
- Umgebungstemperatur : -20 bis 50 °C.
- Maximale relative Luftfeuchtigkeit : 95%, nicht kondensierend, bis zu 40 °C, 75%, nicht kondensierend, bis zu 50 °C
- Höhe : Nicht über 2000 m Meeresspiegel verwenden.  
**Warnung!** Elektrische Creepage & Clearance nicht gültig für größere Höhen!
- Verschmutzungsgrad : 2

## 2.16 Symbole und Markierungen



Vorsichtsgefahr bei elektrischen Schlag.



PE-leiterklemme.



Bedienungsanleitung Symbol. Das Gerät wird mit diesem Symbol gekennzeichnet, wenn der Benutzer auf die Bedienungsanleitung verweisen muss.



Aus (Versorgungsnetz).



Ein (Versorgungsnetz).

## 2.17 Canada

Dieses Produkt wurde nach den Anforderungen von CAN/CSA-C22.2 Nr. 61010.1, zweite Ausgabe, einschließlich Änderungsantrag 1, oder einer späteren Version desselben Standards getestet, die die gleichen Testanforderungen enthält.

## 2.18 cTUVus



## WEEE (Waste Electrical & Electronic Equipment)

### 2.19 Korrekte Entsorgung dieses Produkts

Anwendbar in der Europäischen Union.



Diese Kennzeichnung auf dem Produkt, seiner Verpackung oder seiner Literatur weist darauf hin, dass es am Ende seiner Lebensdauer nicht mit anderen Abfällen entsorgt, sondern separat gesammelt werden sollte, um es verantwortungsvoll zu recyceln, um die nachhaltige Wiederverwendung von Material zu fördern.

## 3 CONSIGNES DE SÉCURITÉ - Série SM3300

### 3.1 Mise en garde

Les précautions de sécurité suivantes doivent être suivies dans toutes les phases de fonctionnement, d'entretien et de réparation de cet appareil. Le non-respect des précautions de sécurité ou des avertissements contenus dans le présent document enfreint les normes de sécurité concernant la conception, la production et l'utilisation prévue de cet appareil et peut endommager les dispositifs de protection intégrés. Delta Elektronika n'est pas responsable si l'utilisateur ne se conforme pas à ces exigences.

### 3.2 Catégorie d'installation

Les alimentations de Delta Elektronika ont été affectées à la catégorie d'installation II (catégorie de surtension II).

### 3.3 Mise à la terre des bornes secteur (bornes d'alimentation CA)

Ce produit est une unité de sécurité de classe 1. Pour minimiser les risques de choc, l'unité doit être connectée au secteur de l'alimentation CA par un câble d'alimentation à trois ou quatre conducteurs pour une unité monophasée ou triphasée, avec le fil de terre fermement connecté à une terre électrique (terre de sécurité) à la prise de courant. Pour les unités conçues pour être câblées à l'alimentation secteur, la borne de terre de protection doit être connectée à la terre électrique de sécurité avant qu'une autre connexion ne soit effectuée. Toute interruption du conducteur de terre de protection ou déconnexion de la borne de terre de protection entraînera un risque de choc potentiel qui pourrait causer des blessures corporelles.

### 3.4 Mise à la terre des bornes CC

Si la borne CC d'une unité est spécifiée pour couler ou s'approvisionner à un maximum de 60 VDC, et que la borne d'alimentation CC 'moins' ou 'plus' est mise à la terre, la tension sur les bornes d'alimentation CC et les connexions de détection peuvent être considérées comme sûres.

**Attention!** Si le bornier CC 'plus' peut dépasser 60 VDC par rapport au bornier CC 'moins', des mesures externes supplémentaires doivent être prises pour assurer l'isolation de sécurité des bornes CC et des connexions de circuit de lecture (marque 'Sense').

**Attention!** Si le bornier CC 'moins' peut dépasser 60 VDC/42,4 Vpk par rapport à la mise à la terre, des mesures externes supplémentaires doivent être prises pour assurer l'isolation de sécurité des bornes CC et des connexions de circuit de lecture (marque 'Sense').

Les connecteurs LAN, USB et de verrouillage standard ainsi que les interfaces optionnelles sont à leur potentiel de mise à la terre et peuvent être considérés comme sûrs si le terminal CC 'moins' de l'appareil par rapport à la mise à la terre ne dépasse pas 1000 VDC / 707 Vpk.

**Attention 1 :** Si les deux bornes CC d'un dispositif basse tension sont sans potentiel ou si les bornes CC sont connectées en série avec une haute tension EXTERNE CA ou CC, le bornier CC-CC 'moins' peut dépasser la valeur de sécurité en termes de mise à la terre comme spécifié dans l'avertissement ci-dessus.

**Attention 2:** Bien qu'un appareil haute tension fonctionne à une tension de sécurité inférieure à 60 VDC, il doit toujours être considéré comme un appareil haute tension pour la sécurité! Un fonctionnement incorrect, une erreur de programmation ou une erreur externe peut entraîner une tension de sortie CC incertaine et élevée. Pour plus d'informations et des schémas de circuit concernant la mise à la terre et la sécurité, voir la note d'application en ligne '*Fonctionnement sûr d'une alimentation électrique*'.

### 3.5 Risque de choc électrique

Toucher les contacts de la fiche d'alimentation ou des câbles immédiatement après la déconnexion du secteur peut entraîner un choc électrique. Et en raison des condensateurs X chargés, un potentiel dangereux entre le terminal CC 'plus' ou 'moins' et le PE peut exister ou survenir. Même si les bornes CC sont éteintes, mais que l'appareil est toujours allumé. Par conséquent, ne touchez jamais PE et l'un des terminaux DC à mains nues en même temps.

### 3.6 Connexion au réseau d'alimentation

Connectez-vous en permanence au réseau d'alimentation ou via une connexion de prise industrielle conformément à la norme CEI 60309. 'Équipement connecté en permanence' ou 'Équipement enfichable de type B'.

### 3.7 Fusibles

Les fusibles ne peuvent être remplacés que par le personnel de service autorisé de Delta Elektronika afin d'éliminer définitivement le risque d'incendie.

### 3.8 Alimentation d'entrée CA

N'utilisez pas une alimentation CA qui dépasse la tension d'entrée CA et la puissance de fréquence de cet appareil. La tension d'entrée CA et la puissance de fréquence de la série d'alimentations Delta Elektronika sont spécifiées dans la fiche technique ci-jointe.

### 3.9 Circuits en direct

Les opérateurs ne doivent pas retirer les couvercles de l'appareil. Les réglages internes ou les remplacements de composants ne sont autorisés qu'au personnel qualifié de Delta Elektronika. Ne remplacez jamais les composants par le câble d'alimentation branché. Pour éviter les blessures, débranchez toujours le courant avant de toucher les composants, retirez les sources de tension externes et les circuits de décharge.

### 3.10 Remplacement et modifications des pièces

Le remplacement et les modifications des pièces ne sont autorisés qu'au personnel de service autorisé de Delta Elektronika. Les réparations de l'appareil ne peuvent être effectuées que par un centre de service Delta Elektronika.

### 3.11 Retrait des couvercles (de sécurité)

Les couvercles de sécurité sont utilisés pour couvrir les tensions potentiellement dangereuses. Gardez les points suivants à l'esprit lorsque vous retirez le(s) couvercle(s) de sécurité :

- Éteignez l'appareil, déconnectez-le du réseau d'alimentation CA et de l'application CC.
- Attendez 5 minutes pour décharger les condensateurs internes. Dévissez et retirez-le(s) couvercle(s).
- Avant de reconnecter l'appareil au réseau d'alimentation, installez-le(s) couvercle(s) à chaque fois.

### 3.12 Manipulation et assemblage

**Attention!** Le poids unitaire est de 27 kg! Lors du déballage ou du changement par précaution: Soulevez avec 2 personnes ou utilisez un outil de levage. Danger d'écraser les membres sous l'unité. Risque de coupe: L'unité a des arêtes vives et des coins!

**Attention!** Aucun montage mural ou au plafond n'est autorisé! Danger d'écrasement sous l'unité. Montez uniquement l'unité horizontalement, placez-la sur une surface stable ou utilisez un support en rack.

### 3.13 Ventilateur rotatif, combustion thermique

Un flux d'air approprié est nécessaire pour refroidir l'appareil. Cela permet un fonctionnement à pleine puissance et une durée de vie plus longue. Si l'appareil surchauffe, l'alimentation s'éteindra jusqu'à ce que l'appareil ait refroidi à nouveau.

**Attention!** Le couvercle supérieur et les échappements du ventilateur peuvent devenir chauds. Évitez de les toucher lorsque vous utilisez l'appareil avec une puissance élevée!

**Attention!** Ne bloquez pas les ouvertures des ventilateurs ou les bouches d'aération. N'essayez pas d'entrer dans les ouvertures des ventilateurs à travers un objet pour obstruer les ventilateurs. Les cheveux longs peuvent rester coincés dans un ventilateur, portez un filet à cheveux si vous avez les cheveux longs.

**Attention!** Ne connectez pas de câbles aux bornes CC lorsque l'appareil est allumé. Soudain, faire ou casser un courant continu élevé peut provoquer de grandes étincelles, même à basse tension. Danger de combustion thermique et d'incendie!

### 3.14 Équipement électromédical

**Attention!** Des courants élevés peuvent traverser les bornes CC. Ces courants provoquent de forts champs magnétiques. Ne vous approchez pas si vous avez un appareil électromédical comme un stimulateur cardiaque.

### 3.15 Conditions ambiantes

L'approbation de sécurité de l'alimentation de Delta Elektronika s'applique aux conditions de fonctionnement suivantes :

- Utilisation : Utilisation à l'intérieur seulement. **Attention!** Non destiné à être utilisé en présence d'enfants ou d'animaux!
- Température ambiante : -20 à 50 °C.
- Humidité relative max: 95%, sans condensation, jusqu'à 40 °C, 75 %, sans condensation, jusqu'à 50 °C
- Altitude: Ne pas utiliser au-dessus de 2000 m niveau de la mer.  
**Attention!** Creepage & Clearance électrique non valable pour les altitudes plus élevées!
- Degré de contamination: 2

### 3.16 Symboles et marqueurs



Risque de prudence en cas de choc électrique.



Terminal conducteur de terre de protection.



Icône du manuel d'instructions. L'appareil est marqué de cette icône lorsque l'utilisateur doit se référer au manuel d'instructions.



Désactivé (réseau d'approvisionnement).



A (réseau d'approvisionnement).

### 3.17 Canada

Ce produit a été testé conformément aux exigences de la norme CAN/CSA-C22.2 no. 61010.1, deuxième édition, y compris l'amendement 1, ou d'une version ultérieure de la même norme qui contient les mêmes exigences d'essai.

### 3.18 cTUVus



## DEEE (Déchets d'équipements électriques et électroniques)

### 3.19 Élimination correcte de ce produit

Applicable dans l'Union européenne.



Cet étiquetage sur le produit, son emballage ou sa documentation indique qu'il ne doit pas être éliminé avec d'autres déchets en fin de vie, mais doit être collecté séparément afin de le recycler de manière responsable afin de promouvoir la réutilisation durable des matériaux.



## 4 QUICK START – SM3300-series

### 4.1 Connecting the unit

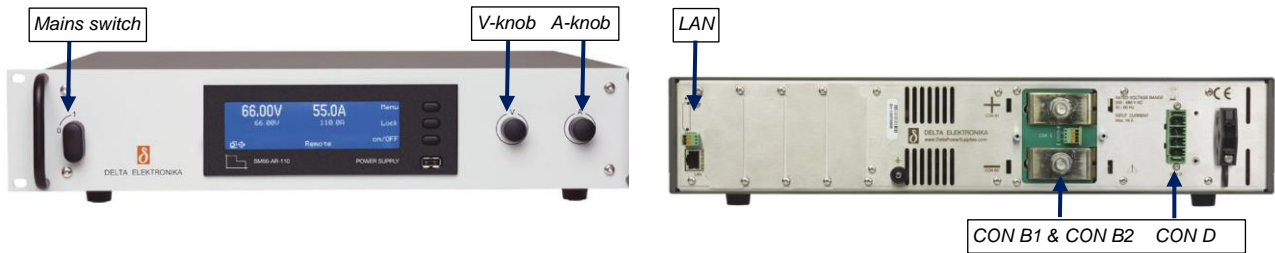

fig 4 - 1 - controls and connections.

**Warning!** Never make connections to the Power Inputs, Power Outputs or Sense Connector when the unit is connected to the mains supply or power outlet! Safety covers are used to cover these in- and outputs. Carefully read the chapter "Safety Instructions" in this manual before connecting or operating the unit!

**Warning!** Some components inside the power supply are at AC voltage even when the On/Off switch is in the off position. Therefore a readily accessible, appropriately rated, disconnect device shall be incorporated external to the equipment. The power supply shall be connected to the mains supply via a protection device with a rating of maximum 16A. For example a circuit breaker or fuses etc.

#### 4.1.1 AC POWER TERMINALS (AC-MAINS)

- This connector is located at the rear side, marked as CON D.
- Use a cable with a diameter of 2.5 mm<sup>2</sup> for each wire and a sufficient voltage rating for the AC input voltage of the unit.
- Use the included 4-pole header with the markings L1, L2, L3 and PE for connecting the wire to the unit (see fig. 4 – 1 and fig. 4 - 2).
- The mounting torque for the header terminals is 0.6 Nm.
- Always connect the PE terminal to the Protective Earth, on a 3-phase grid no neutral connection is required.
- The unit can operate both on a single phase and a 3-phase grid, with a rated voltage of 200...480VAC.
- For a single-phase grid, connect Null and Line between L1 and L2, see fig. 4 - 2.
- After installation, connect the pull relief and add the safety cover over the AC terminals.

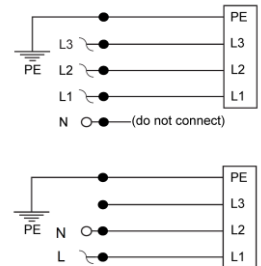

fig 4 - 2  
3 phase & single-phase input connections.

#### 4.1.2 DC POWER TERMINALS

- These terminals are located at the rear side, marked as CON B1 (PLUS) and CON B2 (MINUS), see fig. 4 - 1.
- See table 4 - 1 at this page for the correct cable diameter and mounting torque. Use cables with a sufficient voltage rating for the maximum output voltage of the unit.
- With high output current, use low resistive connections between the power supply and the load:
  - Mount the cable lugs directly on the DC power strips followed by a washer, a split washer and a nut. Always in this order!
  - Never place washers between the lugs and the strips because this can result in excessive heat!
  - Only use nuts and washers supplied with the unit.
- The DC power terminals are floating in relation to Protective Earth.
- After installation mount the safety cover over the DC power terminals.

Unit	DC Output cable [mm <sup>2</sup> ]	Bolts	Torque [Nm]
SM18-220	70	M8	20
SM66-AR-110	35	M8	20
SM100-AR-75	25	M8	20
SM330-AR-22	4	M8	20
SM660-AR-11	2.5	M8	20

table 4 - 1  
Recommended cable diameters and mounting torque.

#### 4.1.3 LAN-CONNECTOR

- Insert a standard RJ45 network cable to the LAN-connector at the rear side, see fig. 4 - 1 and make connection to a Local Area Network (LAN) to perform a firmware update and use the units' web browser, see next paragraph.
- The LAN-connector is at Protective Earth level.

#### 4.1.4 LOAD SENSING, INTERLOCK, USB, INTERFACES, SERIES-PARALLEL, MASTER/SLAVE

- Refer to user manual for connecting and using these features and options.

### 4.2 Operating the unit

#### 4.2.1 FIRMWARE UPDATE

- Switch the unit on by rotating the mains switch on the front panel clockwise.
- In the unit menu, check the firmware revision via Menu > System > info > Unit > Version. Use the V- and A-knob to navigate through the menu.
- On a computer, check at if there is new firmware available via: **Products > SM3300 > Downloads**.
- If newer, download the firmware package to the computer and connect this to the same LAN as the unit.
- In the unit menu, check the IP-address via Menu > Interfaces > LAN > Address\*.
- On the computer, open the SM3300 web interface using an internet browser by entering the IP-address of the unit in the address bar of the browser.
- In the web interface, go to Administration > Firmware.
- Select "Choose File" and browse to the downloaded package, enter password and "Start Update".

*\*Note: when DHCP is enabled, the IP-address can change, for example after a power cycle.*



4.2.2 FIRST OPERATION

- The first line in the front display indicates the actual output voltage and current. The second line shows the settings of the controls.
- Check the text 'front' is indicated - this means the unit is in local-operation and can be controlled by the V-knob and A-knob at the front panel.
- Switch the output on by pressing the on/OFF button.
- Turn the V- and A-knob a half turn clockwise. Depending on the load, a voltage should now be present on the output and a current will run through the load.
- Depending on the load and settings, the unit will be either in constant voltage or constant current mode, respectively CV- or CC-mode.
- Respectively the indication 'CV' will appear on the first line, next to the actual voltage value. The indication 'CC' will appear next to the actual current value.

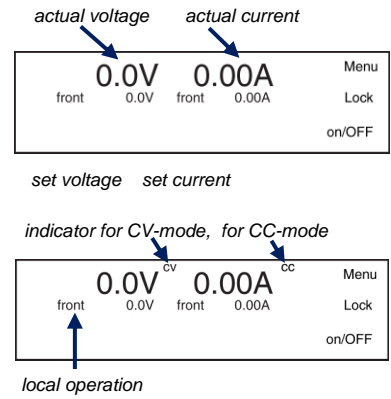

fig 4 - 3 Start up settings.

4.2.3 LIMITATION OF SETTINGS

- By default, the settings for CV and CC Limit are set to the maximum.
- Change the limit settings via Menu > Protection > Limits.

4.2.4 REMOTE PROGRAMMING

- By default a unit is in local operation, see fig. 4 - 4.
- In remote operation different programming options are available such as 'eth', 'web', 'seq', 'slot1', etc.
- Via the front menu the source can be set to the required programming input via: Menu > Configuration > Source.
- When connected to LAN, enter the unit's IP-address in a web browser to open the web interface.
- With this interface all above described parameters plus additional parameters can be set and read.
- For more information, see the chapter Remote Programming of the user manual.

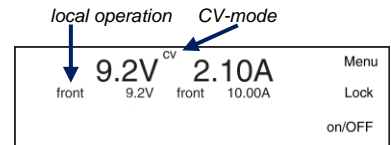

fig 4 - 4 Output power is 19W.

4.3 Download User Manual

4.3.1 FULL VERSION

Check at [www.DeltaPowerSupplies.com](http://www.DeltaPowerSupplies.com) for the full version of the user manual via: [Products > SM3300 > Downloads.](#)

4.4 Driver & Example Software

4.4.1 APPLICATIONS & INTERFACES

- Check at [www.DeltaPowerSupplies.com](http://www.DeltaPowerSupplies.com) for driver and example software via: [Products > SM3300 > Downloads.](#)

Note:

It is strongly recommended to regularly check for updates for additional functionality and improvements.



fig 4 - 5 The front console of the web interface for setting of the output and monitoring various parameters.

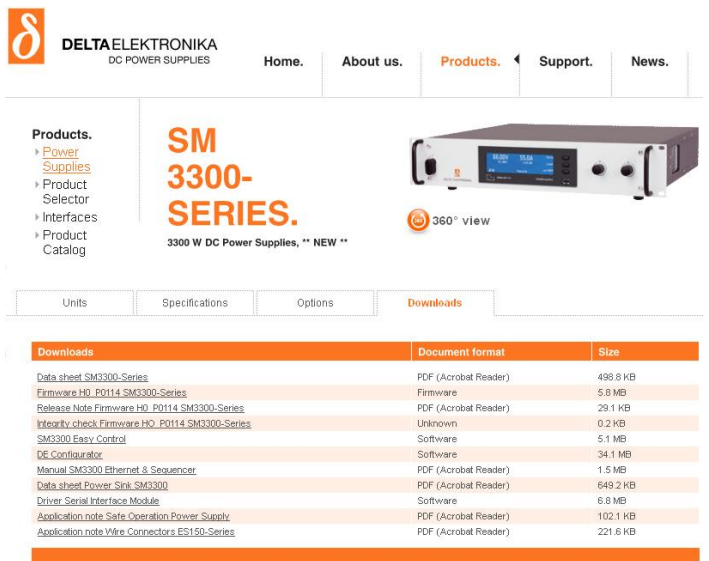

fig 4 - 6 Regularly check for new versions of user manual and firmware.

## 5 GENERAL

### 5.1 DC OUTPUT

- The SM18-220, SM66-AR-110, SM100-AR-75, SM330-AR-22 and SM660-AR-11 can either be used as a constant voltage source with current limiting or as a constant current source with voltage limiting.
- The change of mode occurs sharply at the crossing of the voltage and current settings. Figure 5 - 1 shows the output ranges.

### 5.2 AUTO-RANGE

- The SM66-AR-110, the SM100-AR-75, the SM330-AR-22 and the SM660-AR-11 feature an AUTO-RANGING facility where the power supply automatically switches over between two current ranges. This switching, which is unnoticeable for the user, results in a versatile power supply with twice the output voltage range.
- This means that for the SM66-AR-110 the maximum output power is available at both 33V and 66V.
- For SM100-AR-75 this is at both 50V and 100V, for the SM330-AR-22 this is at both 165V and 330V and for the SM660-AR-11 this is at both 330V and 660V.

### 5.3 MAX OUTPUT POWER

- The standard output range of each of the SM3300 units is chosen in such a way, that the unit can deliver more than 3300W. Most units can deliver around 3600W but this depends strongly on the input voltage and ambient temperature.
- For example the SM18-220 on a three phase 400VAC input voltage can deliver approximately 3700W. Thus at 18V the maximum output current is 205A. When using it on 17V, the maximum current is 220A.
- On 230VAC single phase the power is derated to approximately 3000W, thus delivering maximum 18V / 166A or 13.5V / 220A.
- For the SM18-220 the full range of 18V and 220A (=4000W) cannot be used simultaneously because the input power is limited to 3750W. See datasheet for more details.

### 5.4 OVERLOAD PROTECTION

- The power supply is fully protected against all overload conditions, including short circuit.

### 5.5 INPUT VOLTAGE

- The power supplies work on a single phase or three phase input voltage and have a wide input voltage range.
- In case of a low input voltage, the AC-Fail status will be high. When operating on a 3-phase input voltage, no neutral connection is required.

### 5.6 INPUT CURRENT

- The unit has active power factor correction (PFC). The input current will therefore almost be a sine wave. This means that the RMS-value and the harmonic distortion of the input current will be relatively low.
- The peak inrush current is electronically limited. Switching on and off repeatedly will not result in excessive currents.

### 5.7 INPUT POWER WITH OUTPUT OFF

- The unit consumes very little power when the output is switched off. This makes it possible to leave the input power on when the output is disabled using the Output On/Off function.
- The output can be switched On/Off via a push button on front panel or by remote programming.

SM18-220

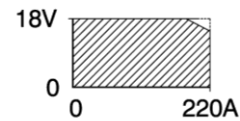

SM66-AR-110

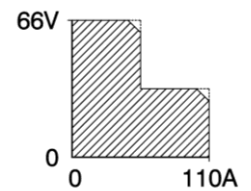

SM100-AR-75

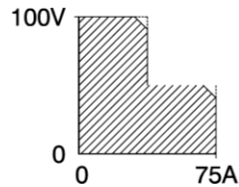

SM330-AR-22

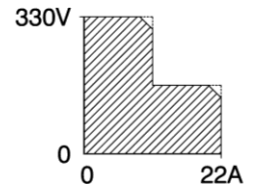

SM660-AR-11

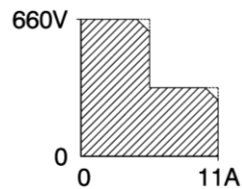

fig 5 - 1  
DC Output voltages and currents.  
Every point in hatched area can be used

**5.8 TURN ON DELAY**

- The output voltage is available very quickly after mains switch on.
- In the datasheet the exact specifications can be found.

**5.9 INRUSH CURRENT**

- The inrush current is electronically limited.
- Repeatedly switching on and off does not change the maximum peak current. Switching on and off at a fast rate can overheat the inrush current limiter. With the result that the unit does not start anymore.
- After cooling down (mains switched off) it will be OK again.

**5.10 EFFICIENCY**

- The efficiency is very high and constant over a wide output current range. High efficiency means low power loss and low heat generation.

**5.11 RIPPLE & NOISE**

- The output ripple is very low with almost no spikes. At low temperatures like -20°C the ripple increases. By using high quality electrolytic capacitors the increase is relatively low.

**5.12 RFI SUPPRESSION**

- Both the input and output have RFI filters, resulting in very low conducted RFI to the line and load. Due to the output filter the output voltage is very clean, having almost no spikes.

**5.13 ROTARY ENCODERS**

- Digital encoders for CV and CC setting with a very long life time and intelligent functions (e.g. Keylock, variable pitch).
- The encoders can also be used for scrolling through the front menu. See fig 5 – 2.

**5.14 VOLTAGE AND CURRENT LIMIT**

- The Voltage Limit will protect your circuit from unwanted high voltages. A high output voltage could be caused by accidental interruption of leads, accidentally turning up the voltage setting, a programming error or a defect in the power supply. The Voltage Limit circuit uses a separate voltage divider connected directly to the output terminals.
- The Current Limit protects your circuit from unwanted high currents.
- The Voltage and Current Limits maintain the output to a safe preset value. They do not trip, so no resetting is needed after a fault.

**5.15 HOLD - UP TIME**

- The hold - up time depends on the load and the output voltage.
- A lighter load or a lower output voltage results in a longer hold - up time (see fig. 5 - 3).

**5.16 REMOTE SENSING**

- The voltage at the load can be kept constant by remote sensing. This feature should only be used when the load voltage is not allowed to vary a few millivolts.
- In order to compensate for the voltage drop across the leads, the unit will have to supply a higher voltage (see fig. 5 - 4).
- The sense leads are protected against accidental interruption.

**5.17 SERIES OPERATION**

- The power supplies can be connected in series without special precautions. For the maximum allowed series voltage, see chapter 'Installation'.
- For easier control, the optional Master/Slave interface is recommended (see fig. 5 - 5). By using the Master/Slave series interface, a dual tracking power supply can be made with one unit as master and one or more units as slave.
- For series operation in combination with Power Sink option, all units must have a Power Sink built inside otherwise no power can be absorbed.

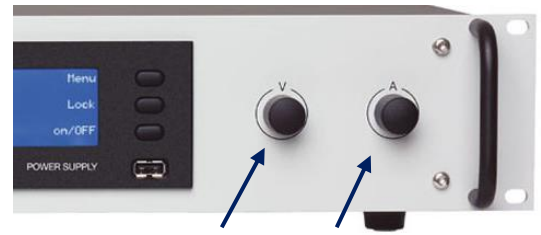

fig 5 - 2

Digital rotary encoders for voltage and current setting and for menu operation.

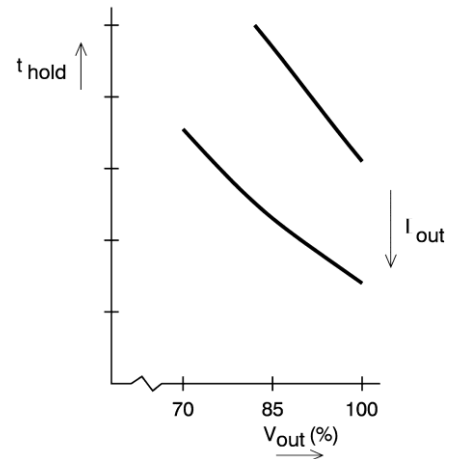

fig 5 - 3

Hold-up time vs.  $V_{out}$  with  $I_{out}$  as a parameter.

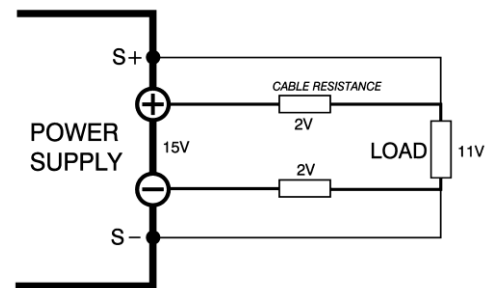

fig 5 - 4

Remote sensing, voltage drop in load leads subtracts from maximum DC output.

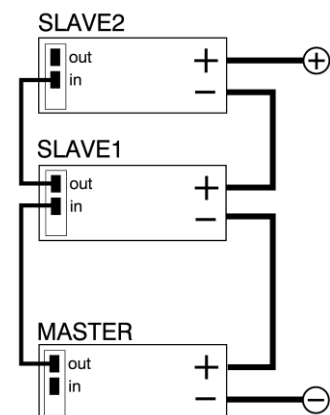

fig 5 - 5

Optional Master / Slave series operation.

## 5.18 PARALLEL OPERATION

- The power supplies can be connected in parallel without special precautions and limitations.
- For easier control, the optional Master/Slave interface is recommended (see fig. 5 - 5 and fig. 5 - 6). By using the Master/Slave series interface, a dual tracking power supply can be made with one unit as master and one or more units as slave.
- For parallel operation in combination with Power Sink option, only one unit can have a Power Sink.

## 5.19 INTERLOCK

- The Interlock connector at the rear panel has an output and an input which have to be connected together to turn on the power output of the unit.
- As soon as the link between the 2 inputs of the Interlock connector is disrupted, the output of the unit shuts down.
- It can be used in combination with a cabinet door contact (safety precaution) or as an emergency brake to stop a motor which is powered by the unit. Once the inputs are connected again, the output will be on.

## 5.20 WEB INTERFACE & ETHERNET PROGRAMMING

- The web interface and Ethernet programming are standard available on all units via LAN connector at the rear side.
- The web interface can be used to view and change the settings for CV, CC, Output On/Off, configure optional interfaces or power sink, to upload new firmware and configure the unit similar as with the front display menu.
- With the build-in Ethernet interface it is possible to program the CV/CC-settings, to read the CV/CC-monitors and the status signals.

## 5.21 SEQUENCER PROGRAMMING

- Possibility to use the unit in stand-alone automation or use as an arbitrary waveform generator and create loops, ramps etc.
- The sequencer can be controlled via the web interface and via Ethernet programming.

## 5.22 OPTIONAL INTERFACES

- Up to a number of 4 different interfaces can be plugged in the sockets at the rear side of the unit.
- All interfaces can easily be plugged in afterwards at the customer site.
- The following types are available:
  - Isolated analog programming & monitoring, logic status outputs.
  - Serial, USB and differential programming.
  - Digital User I/O for programming.
  - Floating Contacts, floating Interlock and floating Enable.
  - Simulation interface for simulation of a photovoltaic curve and other simulation modes.
  - Master/Slave controller.

## 5.23 PROGRAMMING SPEED

- The specified rise and fall times are measured with a step waveform at the Ethernet programming input.
- Programming from a low to a high output voltage is nearly load independent.
- Programming down to a low voltage takes more time on lighter loads. This is caused by the output capacitors, which can only be discharged by the load because the power supply cannot sink current.
- With the Power Sink option, also the programming down speed is nearly load independent.

## 5.24 OPTIONAL HIGH-SPEED PROGRAMMING

- With optional high-speed programming, the rise and fall time is 5 to 25 times faster.
- This option must be built in at the factory and cannot be built in afterwards.
- Note that the output ripple is higher.

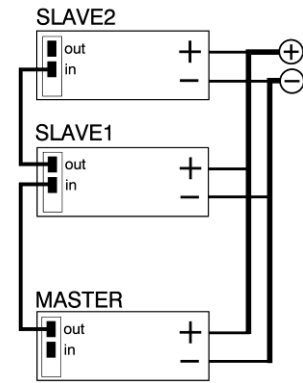

fig 5 - 6

Optional Master/slave parallel operation.



fig 5 - 7

Different interface modules can be plugged in.

## 5.25 OPTIONAL POWER SINK

- With optional power sink, the output voltage setting is maintained when there is power fed back into the unit.
- Ideal for fast discharge of the output at no-load conditions.
- For series operation in combination with Power Sink option, all units must have a Power Sink built inside otherwise no power can be absorbed.
- For parallel operation in combination with Power Sink option, only one unit can have a Power Sink.
- Configuration can be done via the web interface.
- This option must be built in at the factory and cannot be built in afterwards.

## 5.26 COOLING

- A low noise blower cools the unit. The speed of the fan depends on the temperature of the internal heatsink. Normally, at 50 °C ambient and full load the fan will not work at full speed.
- A special feature is that the fan blows through a tunnel where the heatsink is situated, the delicate control circuitry is separated and will not be in the airflow path (see fig. 5 - 8).
- Because the air enters at the left and exits at the right side, it is possible to stack the power supplies, no distance between the units is required.

## 5.27 OPERATING TEMP

- At full power, the operating temperature range is -20 to +50 °C. From 50 to 60 °C the output current has to be derated linearly to 75% at 60 °C (see fig. 5 - 9). These temperatures hold for normal use, i.e. the ventilation openings on the left and right side must be free.

## 5.28 THERMAL PROTECTION

- A thermal protection circuit shuts down the output in case of insufficient cooling. The display will show a thermometer symbol and the OT-status will be active. After cooling down, the unit will start working again.

## 5.29 FIRMWARE UPGRADING

- Warning! never update with the serial or simulation interface(s) inside a unit. First remove the interface, do the upgrade and then place the interface back in position.
- Regularly check for firmware updates at the Delta Elektronika website. If there is a new update available, the unit can be updated via the standard web interface.
- This document is based on P0157.

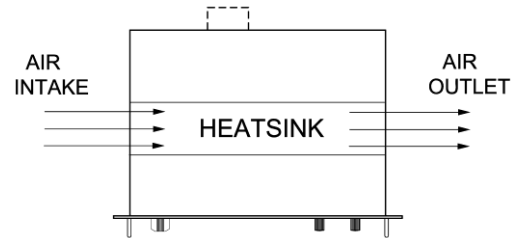

fig 5 - 8

The fans blow through the tunnel where the heatsink is situated.

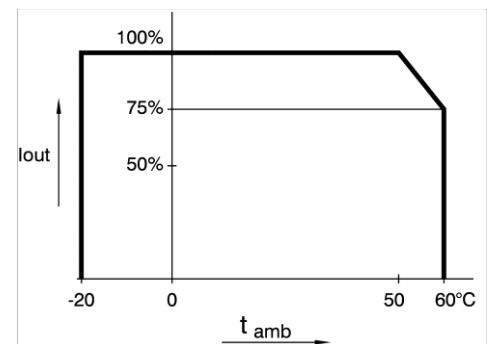

fig 5 - 9

Operating temperature ranges.

## 6 INSTALLATION

- **Warning!** carefully read the chapter "Safety Instructions" in this manual before connecting or operating the unit!

### 6.1 HUMIDITY & CONDENSATION

- During normal operation, humidity will not harm the power supply, provided the air is not aggressive. The heat normally produced in the power supply will keep it dry.
- Avoid condensation inside the power supply, to prevent break-down. Condensation can occur during a period the power supply has been switched off (or operating at no load) and the ambient temperature is increasing. Always allow the power supply to dry before switching it on again.

### 6.2 TEMPERATURE & COOLING

- The storage temperature range is -40 to +70 °C.
- The operating temperature range at full load is -20 to +50 °C.
- This temperature range only holds when the air-intakes and air-outlets are unobstructed and the temperature of the air-intake is not higher than +50 °C.
- When the power supply is mounted in a cabinet, please note that the temperature of the air-intake should be kept low and avoid a short circuit in the airflow i.e. the hot air leaving the air-outlets entering the air-intakes again.
- Please note: a lower temperature extends the lifetime of the power supply.

### 6.3 19" RACK MOUNTING

- On both sides in the rack, mount a proper support slide that can hold the weight of the unit. It is advised to use a separate slide for each unit.
- After placing the unit on the slide, add all 4 screws to mount the front panel of the power supply to the vertical rack posts. Use proper screws intended for keeping equipment of this weight in position.
- Assuming the rack is deliberately designed for the weight, stacking of the units is allowed without limitations. See previous paragraph for cooling instructions.

### 6.4 CONNECTING THE UNIT

- **Warning!** Never make connections to the Power Inputs and Outputs or the Sense Connector when the unit is connected to the mains supply or power outlet!
- Safety covers are used to cover these in- and outputs.
- Observe the following when removing a safety cover: Switch off the unit and disconnect from the mains supply.
- Wait for 5 minutes to allow internal capacitors to discharge.
- Unscrew the screws and remove the safety cover.
- Place the safety cover back on the unit before connecting it to the mains supply again.
- **Warning!** Some components inside the power supply are at AC voltage even when the On/Off switch is in the off position. Therefore a readily accessible, appropriately rated, disconnect device shall be incorporated external to the equipment.

The power supply shall be connected to the main supply via a protection device with a rating of maximum 16A. For example a circuit breaker or fuses etc.

#### 6.4.1 AC POWER TERMINALS (AC-MAINS)

- This connector is located at the rear side, marked as CON D.
- Use a cable with a diameter of 2.5mm<sup>2</sup> for each wire. Use a cable with a sufficient voltage rating for the input voltage of the unit.
- Use the included 4-pole header with the markings L1, L2, L3 and PE for connecting the wire to the unit. The mounting torque for the header terminals is 0.6Nm.
- Always connect the PE terminal to the Protective Earth.
- The unit can operate on a single phase or a 3-phase grid (see fig. 6 - 2), see the chapter 'Specifications' for the minimum and maximum values.

Unit	DC Output cable [mm <sup>2</sup> ]	Bolts	Torque [Nm]
SM18-220	70	M8	20
SM66-AR-110	35	M8	20
SM100-AR-75	25	M8	20
SM330-AR-22	4	M8	20
SM660-AR-11	2.5	M8	20

table 6 -1  
Recommended cable diameters and mounting torque.

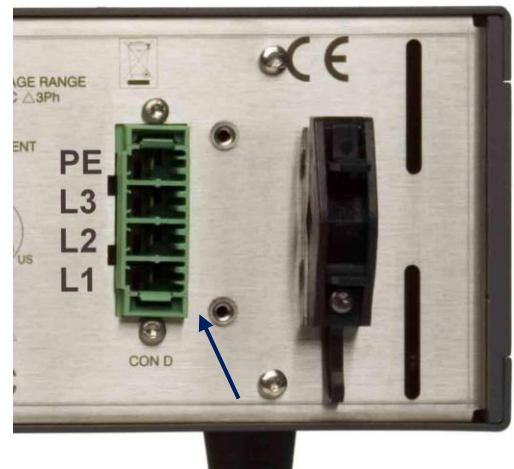

fig 6 - 1  
Insert the included 4-pole header in CON D for the connection of the AC power / Mains.

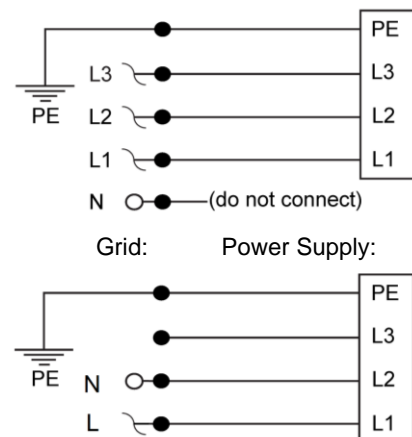

fig 6 - 2  
The 3 phase and 1 phase connections for AC Mains.



- No neutral connection is required on a 3-phase grid.
- For a single-phase grid, connect between L1 and L2.
- After installation, connect the pull relief and add the safety cover over the input.

6.4.2 DC POWER TERMINALS

- These terminals are located at the rear side, marked as CON B1 and CON B2.
- For cable diameters and mounting torque (see table 5 - 1).
- Use cables with a sufficient voltage rating for the output voltage of the unit.
- With high output current, make sure to use low resistive connections between the power supply and the load:
  - Before connecting the power cables, first remove the remote sensing connector in order not to damage it.
  - Mount the cable lugs directly on the output strips followed by a washer, a split washer and a nut (see fig. 6 - 4). Always in this order!
  - Never place washers between the lugs and the strips because this can result in excessive heat!
  - Only use nuts and washers supplied with the unit.
- Minimize the inductance in the leads by keeping them close to each other or by using a multi-strand cable.
- The power outputs are floating in relation to the PE.

6.4.3 DC LOAD SENSING (REMOTE SENSING)

- This connector is located at the rear side, marked as CON C.
- Use the included 4-pole header for connecting the sense wires to the unit. By pressing the orange clips with a small screwdriver, the wires can be inserted or released.
- When local sensing, check there is a link between + and S+ and between - and S- on the sense header (default).
- For remote sensing, please first read the paragraph 'Remote Sensing' for more details.
- For remote sensing, remove the links between + and S+ and - and S- from the header and connect sense leads to the inputs for S+ and S-.
- Use cables with a diameter of 0.3 ... 0.5mm<sup>2</sup> and with a sufficient voltage rating for the output voltage of the unit. The leads are only thin measuring wires but always have to be shielded. In order to prevent interference, it is advisable to twist the leads. See fig. 6 - 5.
- With regards Safety, the sense terminals are at the level of the Power Outputs. After installation add the safety cover over the power output.

6.4.4 LAN-CONNECTOR

- This connector is located at the rear side, marked as LAN.
- For Ethernet programming or Web Interface control, insert a standard RJ45 cable in the LAN connector at the rear side.
- With regards Safety, the LAN connector is at the level of Protective Earth.

6.4.5 INTERLOCK CONNECTOR

- This connector is located at the rear side, marked as CON A.
- Use the included 3-pole header for connecting the interlock wires to the unit. By pressing the orange clips with a small screwdriver, the wires can be inserted or released.
- For more details and specifications about Interlock, please read the paragraph 'Interlock Function' in this chapter.
- When the Interlock function is not used, connect a link between terminal 1 and 3 of the Interlock header (default).
- Use cables with a diameter of 0.3 ... 0.5mm<sup>2</sup> and with a sufficient voltage rating for the voltage of the circuit.
- With regards Safety, the Interlock connector is at PE level.

6.4.6 FRONT USB-CONNECTOR

- This connector is located at the front panel, in the lower right corner under the display.
- With firmware package P0157, this connector is still disabled.
- With regards Safety, the Front USB-connector is at PE level.
- The USB connector is meant for direct connection of flash drives.



fig 6 - 3  
The two DC power terminals CON B1 and B2.  
In between them the sensing connector.

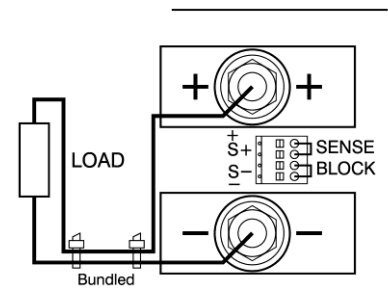

fig 6 - 4  
Local sensing with the power cables bundled close together to minimize inductance.

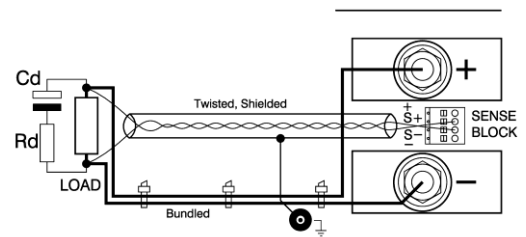

fig 6 - 5  
Remote sensing with shielded twisted wires and the power cables bundled close together to minimize inductance.

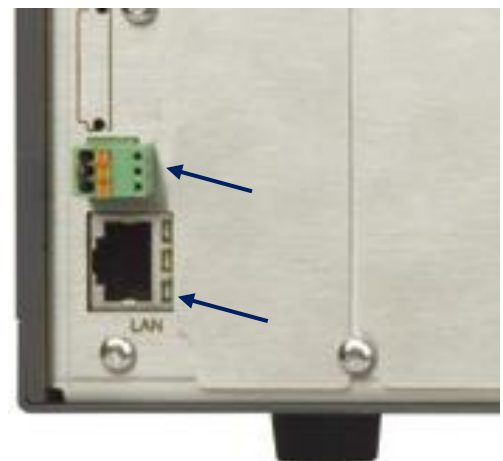

fig 6 - 6  
The location of the LAN-connector (left) and the Interlock connector (right) at the rear panel.



6.4.7 OPTIONAL INTERFACES

- For programming via an optional interface, refer to the interface manual for installation and cable connections.

6.5 INSULATION

- The insulation of the separating components between input and output, such as transformers and opto-couplers, is tested before assembly during 1 minute @ 3750 Vrms (5300VDC).
- The insulation between input and Protective Earth (3500VDC) and between output and PE (1000VDC) is tested after assembly.
- **Note1:** the specified insulation between input and output cannot be tested afterwards on the assembled unit!
- **Note2:** when testing the insulation, take care to charge and discharge the capacitors between input - case and output - case slowly (e.g. in one second). This to prevent high peak currents, which could destroy the power supply. Make sure to discharge the capacitors completely before using it again.

6.6 REMOTE SENSING

- **Warning!** This feature is not recommended for normal use, because damping is critical and wrong connection or routing can lead to instabilities.
- With remote sensing, the voltage on the load can be kept constant. The voltage drop in the load leads will be compensated.
- Max. 2.5 V per load lead can be compensated.
- Note that the voltage drop in the leads decreases the maximum output voltage rating:  $U_{out} = U_{leads} + U_{load}$ .
- In fig. 6 - 9 it can be seen that on a 15 V unit, only 11 V will be available on the load when 2 x 2 V compensation is used.
- To minimize the inductance in the leads of the power output, keep them close to each other. The inductance of the load leads could give a problem with pulsating loads.
- In this case a large electrolytic capacitor (Cd) in series with a damping resistor (Rd) both in parallel with the load will help (see fig. 6 - 10). Check that the capacitor Cd in combination with the load leads and resistor Rd forms a well damped circuit.
- Since the voltmeter is internally connected to the sensing terminals, it will automatically display the voltage on the load. Note that the voltage measured on the load will be lower than on the output terminals.
- The voltage limit measures the voltage on the output terminals, so the limit setting should be increased by the total voltage drop in the load leads.
- For sensing on a pulsating load, see paragraph 'Special Applications' of this chapter.

6.7 INTERLOCK FUNCTION

- The interlock connector has one output (pin1) and one input (pin3). Pin2 is not used. As soon as the link between pin 1 and 3 is disrupted, the power output of the unit will shut down.
- If the link is open, the interlock symbol is flashing in the display, see fig. 6 - 11 and the interlock status will be active.
- Connecting the terminals will switch the output on again.
- **Warning!** The terminals can only be connected to a floating contact, for example a switch or a relay. Internally the terminals are connected to a logic circuit which cannot be charged or loaded!
- The current through a closed contact is less than 1mA.
- The voltage over the open contact is 3.3V (typical).
- It is not possible to connect the interlock of multiple SM3300 units in parallel.
- With regards Safety, the Interlock connector is at PE level.
- On optional interface ISOLATED CONTACTS, a floating interlock connector is available. See chapter 7 of this manual.
- The maximum Interlock wiring length is 3 meters.

6.8 SERIES OPERATION

- The power supplies can be connected in series without special precautions.



fig 6 - 7  
The location of the front USB-connector.

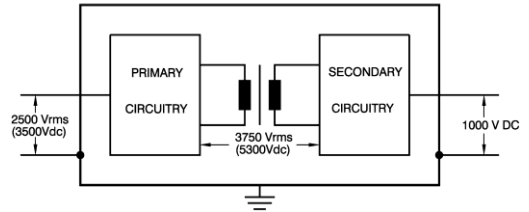

fig 6 - 8  
Insulation test voltages.

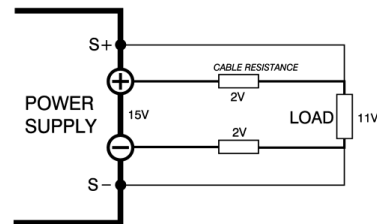

fig 6 - 9  
Remote sensing: voltage drop in DC load leads subtracts from the maximum DC output voltage.

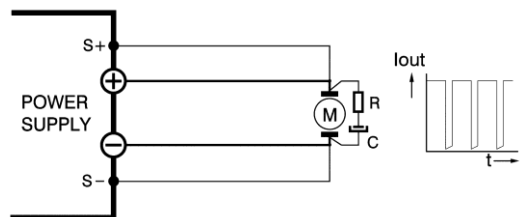

fig 6 - 10  
Remote sensing on a pulsating load.



fig 6 - 11  
The Interlock symbol will be visible in the display when the link is interrupted.

- The operational isolation of a unit allows for a maximum total series voltage. See 'Datasheet Interfaces SM3300 series' for details.
- **Warning!** The minus power output of the unit is allowed to be maximum 1000VDC higher or lower than the Protective Earth, regardless of the higher allowed series voltage!
- For more details, see Safety Instructions in chapter 2.

**6.9 PARALLEL OPERATION**

- The power supplies can be connected in parallel without special precautions. Paralleling of the units has no limitations.
- Normal parallel operation of units High Speed Programming units can give problems. Each combination has to be tested first, in combination with the load!

**6.10 OPTIONAL MASTER / SLAVE CONTROL**

- For easy series or parallel operation the Master / Slave interface is advised.
- Master / Slave parallel operation of High-Speed Programming units is not recommended.
- See chapter 7 for more information about the M/S interface.

**6.11 OPTIONAL POWER SINK**

**6.11.1 SETTING UP THE POWER SINK**

- Settings for disabling/enabling can be made via the web interface, see chapter 7.

**6.11.2 POWER SINK OVERLOAD (PSOL)**

- If the maximum sink power has been reached, the Power Sink will go in overload and the sink current will be limited. In this situation the Sink cannot absorb more power and the output voltage of the supply will rise.
- On the front panel the PSOL icon will be blinking and the status output 'PSOL' will be high.

**6.11.3 THERMAL OVERLOAD (OT)**

- If the Power Sink runs hot, the fan starts blowing to cool it down. Once the situation of thermal overload has been reached, the Power Sink and the output shut down completely until the internal heat sink has cooled down again. In this OverTemp situation the OT-status will be high.

**6.11.4 SERIES OPERATION**

- For series operation in combination with Power Sink option, all units must have a Power Sink built inside otherwise no power can be absorbed.
- When using Master/Slave mixed parallel/series operation, automatically the Power Sink will be disabled for both Master and all Slaves.

**6.11.5 PARALLEL OPERATION**

- For parallel operation in combination with Power Sink option, only one unit can have a Power Sink. The output voltage of this unit must be set 0.5% higher than the other units (to avoid unintended sinking of Slave power).
- When using Master/Slave parallel operation, always set the unit with the power sink as master. The firmware will automatically reduce the voltage setting with of each Slave with 0.5% to avoid unintended sinking and disable the Power Sink in each Slave.
- When using Master/Slave mixed parallel/series operation, automatically the Power Sink will be disabled for both Master and all Slaves.

**6.12 SPECIAL APPLICATIONS**

**6.12.1 PULSATING LOAD**

- To avoid overheating the output capacitors, the AC component of the load current should be limited (see fig. 6 - 13).
- One method of reducing the AC current through the output capacitor is by using a large external electrolytic capacitor in parallel with the load. Care must be taken so that the capacitor in combination with the lead inductance will not form a series resonant circuit!
- When using remote sensing on a pulsating load (for instance a DC-motor), use a capacitor in series with a resistor over the

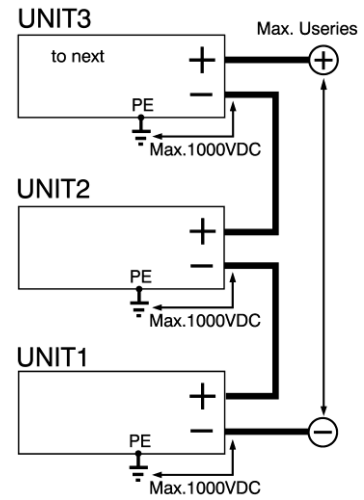

fig 6 - 12

For series operation the maximum series voltage is between 1000VDC and 1400VDC. Never exceed the 1000 VDC between the minus power outputs and PE!

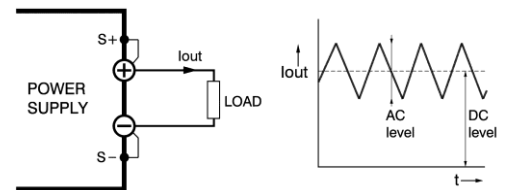

fig 6 - 13

Pulsating load current.

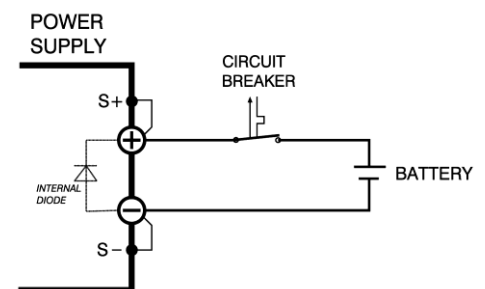

fig 6 - 14

Charging battery with a circuit breaker in series to protect the internal diode.

load (see fig. 6 - 10). Like this the AC-component caused by the pulsing of the load is filtered.

- Note: in case of a pulsating load, the I monitor voltage will not exactly match the output current. This is mainly caused by the current through the output capacitors. Remote sensing will worsen this effect.

6.12.2 BATTERY CHARGER

- The CV / CC regulated power supplies are ideal battery chargers. Once the output is set at the correct voltage the battery will charge constantly without overcharging. This can be useful for emergency power systems.
- Use a Circuit Breaker in series in order to protect the power supply from accidental reverse connection (see fig. 6 - 14).
- The unit has a reverse diode in parallel with the output, this diode and the wiring cannot withstand the thousands of amperes supplied by a wrongly connected battery.
- The circuit breaker should have a DC voltage rating twice the battery voltage. Use the very fast type (Z), a type meant for protecting semiconductors (see table 5 - 2).

6.13 OPERATING THE UNIT

6.13.1 FIRST OPERATION

- Switch the unit ON by rotating the mains switch on the front panel clockwise.
- The first line in the front display does indicate the actual values for the output voltage and current. See fig. 6 - 15.
- The second row shows the settings of the controls for the voltage and current. If the unit is in local operation, the text 'front' is indicated before the settings values. If the unit is set to remote programming, for example Ethernet programming, the text 'eth' is indicated. See fig. 6 - 15...18.
- The right side of the display shows the texts 'Menu', 'Lock' and 'ON/off'. Press the push buttons right from these texts to operate the following item:
  - \* Menu: this will enter the main menu of the unit. See the next chapter for the different choices and settings.
  - \* Lock: pressing this button for about 4-5 seconds will lock the rotary encoders and/or the display menu. Pressing this button again for 4-5 seconds, will unlock the encoders and/or the display menu. This function can be useful to protect the output from accidental shutdown. See next chapter for exact possibilities of the 'Lock' function.
  - \* On/Off: pressing this button will switch the output on or off.
- If the unit is equipped with a Power Sink, via the web server it can be chosen to also switch this off, or leave it on.
- Check if the unit is in local operation: the text before the set values on the 2nd row must be 'front'. See fig. 6 - 16.
- Switch on the output by pressing the ON/off button.

6.13.2 CV- and CC-control

- Turn both the CV and CC encoder a few turns clockwise.
- A voltage should now be present on the output.
- Under the values for the actual output voltage and current, the display does always show the settings of the CV- and the CC-encoders. See fig. 6 - 16.
- Depending on the load and the settings, the unit will be either in CV or in CC mode. See fig. 6 - 17.
- Respectively the indication 'CV' will appear on the first line, next to the actual voltage value. The indication 'CC' will appear next to the actual current value.

6.13.3 CV- and CC-limit

- In the default configuration, both the settings for CV- and CC-limit are set to the maximum values.
- To set the limits to a lower value, go to Menu -> Protection -> Limits. Here set both Voltage and Current limits.

6.13.4 REMOTE PROGRAMMING

- Before the set values, the selected source is shown, see fig. 6- 18. For example 'eth', 'web', 'seq', 'slot1' etc.
- For more information, see chapter 7 of this manual.

6.13.5 FRONT ICONS

Suggested circuit breakers for protection power supply			
Model	Type nr.	Brand	Remarks
SM18-220	HT1102 B 125	GE	2 poles parallel
SM66-AR-110	HT1102 B 100	GE	2 poles parallel extra parallel diode on output needed
SM100-AR-75	HT1101 B 100	GE	No remarks
SM330-AR-22	S281 UC-Z 50 or S282 UC-Z 20	ABB	Extra parallel diode on output needed
SM660-AR-11	FHL 3603013	Schneider Electric	2 poles in series extra parallel diodes on output needed

table 6 - 2  
Circuit breakers for protection.

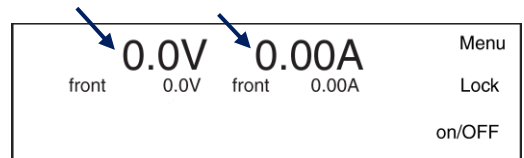

fig 6 - 15  
The first line in the display shows the actual output value for voltage and current.



fig 6 - 16  
The second line shows the set value for voltage and for source current.

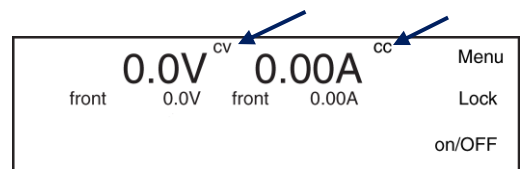

fig 6 - 17  
A unit is either in CV or CC mode, indicated next to the actual values of respectively the output voltage or output current.

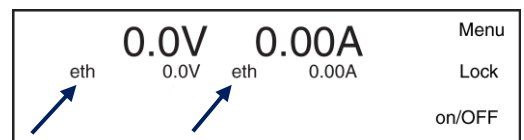

fig 6 - 18  
The programming source appears before the settings. In this example both CV and CC settings are controlled via Ethernet.

**AC FAIL**

- This indicator is active if the input voltage is too low / too high.

**DC FAIL**

- This indicator is active if the output is 5% below or above the set value.

**OVER TEMPERATURE**

- This indicator is active if the temperature of the heatsink is higher than 90°C. The output will shutdown until the temperature has dropped below 80°C.

**LIMITER**

- This indicator is active if one of the settings for CV or CC is limited.

**SIMULATION**

- This indicator is active when the programming source is being compensated by the optional simulation interface.

**LAN**

- This indicator is active if the unit is connected to a LAN.

**INTERLOCK**

- This indicator is active if the terminals of the interlock connector have been interrupted.

**COMMUNICATION WATCHDOG**

- This indicator is active if the communication watchdog timer had expired\*\*.

**REMOTE SHUTDOWN**

- This indicator is active if the output of the unit is shutdown via the ETH connection, or via an optional interface.

**USB**

- Not available in firmware package P0157.

**POWERSINK OVER LOAD**

- This indicator is active if absorbed power of the optional Power Sink is too high.

**SMIN / SPLUS BREAK**

- Not available in firmware package P0157.

**CV- OR CC-MODE**

This indicator will indicate if a unit is operating in CV or CC mode.

**CONTROLS LOCKED**

- This indicator is active if the rotary encoders on the front panel are locked.

**INTERNAL ERROR**

- This indicator is active if there is an internal error, or when an interface is not correctly configured. Verify the "System information" page of the web interface. Or contact support.

**INTERFACES**

- This indicator is active if there is an interface build inside one of the slots at the rear side.

**MASTER or SLAVE**

- The standard interface icon is replaced by a Master or a Slave icon if the optional Master Slave interface is configured as a Master or a Slave.

**SEQUENCER RUNNING / PAUSE / STOP**

- These indicators show the status of the Sequencer.

*Note: If both the interlock and watchdog indicator conditions are true, the symbols will be displayed in an alternating way.*

LIM		
SIM		
CV	CC	

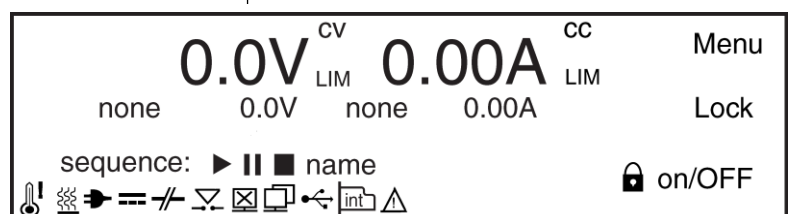

fig 6 - 19  
Location of icons on the front display.

## 7 FRONT MENU OPERATION

### 7.1 ACCESSING THE MAIN MENU

- After switching on the unit, the right side of the display shows the texts 'Menu', 'Lock' and 'on/Off' (see fig. 7 - 1). Press the upper push button right from the text 'Menu' to enter the menu of the unit.
- Operate the left rotary encoder marked 'V' to choose one of the sub menus.
- To change a setting, operate the right encoder marked 'A'.
- By using the upper or middle push buttons, one can respectively go back to the previous menu level (Back) or go deeper in the menu (Select). See below paragraphs for the possibilities.
- In every menu level, it is possible to switch the DC power output on or off, using the lower push button.

### 7.2 MENU MAP

- The overview in fig. 7 - 2 shows the tree structure of the main menu. Not all items are already implemented in the present firmware package. Regularly check the Delta Elektronika website for new releases. The unit can be updated with the latest package via the web interface.

### 7.3 MENU SETTINGS

#### 7.3.1 SYSTEM INFO

##### UNIT

###### VERSION

- Displays the version of the firmware package.

###### SERIALNR

- Displays serial number

###### PUD

- Displays 'Protected User Data'

##### STATUS

###### TEMPERATURE

- Displays the highest temperature inside the power supply.

###### INPUT

Displays mains Vac and Iac.

#### 7.3.2 CONFIGURATION

##### FRONT SETTINGS

###### LCD SETTINGS

###### LIGHT ON

- Select the setting of the display back light level during operation of the rotary encoders or the push buttons.
- A range of 20 - 100% is available.
- The default setting is 50%.

###### LIGHT DIM

- Select the setting of the normal display back light level.
- A range of 0 - 100% is available.
- The default setting is 20%.

###### DIM DELAY

- Select the time after which the display switches back from a high level during encoder or button operation, and the normal back light level.
- A range of 0 - 200 seconds is available (0 = do not dim).
- The default setting is 5 seconds.

###### CONTRAST

- Select the setting of the display contrast.
- A range of 0 - 100% is available.
- The default setting is 60%.

##### INDICATORS

- There are 13 different indicators available: OT, ACF, DCF, PSOL, Interlock, RSD, Internal error, LAN, V-limit, I-limit, USB, Sequencer and Interfaces.
- Select the setting for each indicator separately.
- Possible settings are NONE, VISUAL, AUDIO and VISUAL&AUDIO.

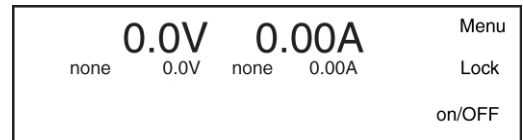

fig 7 - 1

At the right side of the display, the 3 main menu items can be chosen.

#### SYSTEM INFO

##### UNIT

VERSION  
SERIALNR  
PUD

##### STATUS

TEMPERATURE  
INPUT

#### CONFIGURATION

##### FRONT SETTINGS

LCD SETTINGS  
LIGHT ON  
LIGHT DIM  
DIM DELAY  
CONTRAST

##### INDICATORS

SOUNDS  
LANGUAGE

##### POWER-ON STATE

VOLTAGE  
CURRENT  
OUTPUT

##### PRG SOURCE

V-SETTINGS  
I-SETTINGS

##### POWER SINK

STATUS  
SETTINGS

##### MASTER SLAVE

STATUS  
SETTINGS

##### SETUP

RECALL SETUP  
SAVE SETUP

#### PROTECTION

##### ACCESS SECURITY

CHANGE KEY  
LOCK OPTIONS  
UNLOCK OPTIONS

##### LIMITS

VOLTAGE LIMIT  
CURRENT LIMIT

#### INTERFACES

##### LAN

ADDRESS  
SUBNETMASK  
GATEWAY  
DHCP  
IP-VERSION  
MAC-ADDRESS

##### SLOTS

OVERVIEW

fig 7 - 2

Menu tree structure.

### SOUNDS

- Select the sound for each indicator separately.
- Possible settings are 1xCHANGE, 3xCHANGE, DOWNWARDS and CONTINUOUS BEEP.

### LANGUAGE

For firmware package P0120 the language available is 'ENGLISH'.

## POWER-ON STATE

### VOLTAGE

- Select CV setting of the unit after mains switch on.
- Possible settings are ZERO, FIXED VALUE and RESTORE VALUE.
- Default setting is ZERO.

### CURRENT

- Select CC setting of the unit after mains switch on.
- Possible settings are ZERO, FIXED VALUE and RESTORE VALUE.
- Default setting is ZERO.

### OUTPUT

- Select OUTPUT ON / OFF-setting of the unit after mains switch on.
- Possible settings are DISABLED, ENABLED and RESTORE VALUE.
- Default setting is DISABLED.

## PRG SOURCE

### V-SETTINGS

- Select programming source for the CV-setting.
- Possible settings are NONE, FRONT, ETH, WEB, SEQ and SLOT1...4.
- Default setting is FRONT.

### I-SETTINGS

- Select programming source for the CC-setting.
- Possible settings are NONE, FRONT, ETH, WEB, SEQ and SLOT1...4.
- Default setting is FRONT.

## POWERSINK

### STATUS

- Displays current state
- Displays the temperature of the power sink

### SETTINGS

- Shows the settings for the optional power sink.
- Settings can be done via the web interface as well.
- Possible settings are Power Sink disabled/enabled, Power Sink on RSD, Interlock and/or Output On/Off.

## MASTER SLAVE

### STATUS

- Displays id number, configuration status and number of units (if device is master).

### SETTINGS

- Select and view the setting for the master/slave interface.
- Selection can be done via front or via the web interface.
- Possible settings are master, slave or off.
- Select nr of units in parallel or in series.

## SETUP

### RECALL SETUP

- Recall an earlier saved setup of the menu settings, voltage and current settings and limits, network settings.
- Choose Setup1, Setup2 or Setup3.

### SAVE SETUP

- Save the present settings.



### 7.3.3 PROTECTION

#### ACCESS SECURITY

##### CHANGE KEY

- Select the 4-digit access key.
- Default setting is '0000'.
- In case of a forgotten access key see troubleshooting, chapter 8.

##### LOCK OPTIONS

- Select which functions are blocked with the 'LOCK' function.
- Possible settings are 'Menu' and 'Menu & Controls'.
- Default setting is 'Menu & Controls'.

##### UNLOCK OPTIONS

- Select how to unlock the unit. To make a selection, first the 4-digit access key must be entered.
- Possible settings are 'With Key' and 'Without Key'.
- Default setting is 'Without Key'.

#### LIMITS

##### VOLTAGE LIMIT

- Select the setting for the Voltage limit.
- Possible settings are 'DISABLED' and 'FIXED VALUE'.
- Default setting is 'DISABLED'.

##### CURRENT LIMIT

- Select the setting for the Current+ limit.
- Possible settings are 'DISABLED' and 'FIXED VALUE'.
- Default setting is 'DISABLED'.

### 7.3.4 INTERFACES

#### LAN

##### ADDRESS

- Select / View the present IP-address.
- The default setting is 169.254.0.2.

##### SUBNETMASK

- Select / View the present Subnet-mask.
- The default setting is 255.255.0.0.

##### GATEWAY

- Select / View the present Gateway-address.
- The default setting is 169.254.0.1.

##### DHCP

- Select the setting for DHCP.
- Possible settings are 'Enabled' and 'Disabled'.
- Default settings is 'Enabled'.

##### IP-VERSION

- View the IP-version.
- For firmware package P0120, this version is V4.

##### MAC ADDRESS

- View the unique MAC-address.
- The address is in the range of F4:E1:42:xx:xx:xx.

#### SLOTS

##### OVERVIEW

- Shows the optional installed interfaces in Slot1, 2, 3 and 4.

### 7.4 FIRMWARE UPDATING

- Check the version of the firmware in the unit via Menu > System Info > Unit > Version.
- Go to and check if there is new firmware available via Products -> SM3300 -> Downloads.
- Download the new firmware package to the computer.
- Connect the unit to the above computer via LAN and open the web interface using an internet browser.
- The web interface is found by entering the IP-address of the unit in the address bar of the browser. The IP-address is found via Menu > Interfaces > LAN > Address.



- Note: when DHCP is enabled the IP-address can change, for example after a power cycle.
- In the web interface, go to Administration -> Firmware.
- Select "Choose File" and browse to the downloaded package.
- Enter password and "Start Update". See below figures 7 – 2 and 7 - 3 for the download locations on our website, and a screen shot of the web interface.
- Recommended firmware package is P0157.

The screenshot shows the Delta Elektronika website for the SM3300-Series. The page features a navigation menu with 'Products' selected. A sidebar lists product categories like 'Power Supplies', 'Product Selector', and 'Interfaces'. The main content area displays 'SM 3300-SERIES. 3300 W DC Power Supplies, \*\* NEW \*\*' with a 360-degree view icon and a product image. Below this is a 'Downloads' section with a table of available files.

Downloads	Document format	Size
<a href="#">Data sheet SM3300-Series</a>	PDF (Acrobat Reader)	498.8 KB
<a href="#">Firmware.H0_P0114 SM3300-Series</a>	Firmware	5.8 MB
<a href="#">Release Note Firmware H0_P0114 SM3300-Series</a>	PDF (Acrobat Reader)	29.1 KB
<a href="#">Integrity check Firmware H0_P0114 SM3300-Series</a>	Unknown	0.2 KB
<a href="#">SM3300 Easy Control</a>	Software	5.1 MB
<a href="#">DE Configurator</a>	Software	34.1 MB
<a href="#">Manual SM3300 Ethernet &amp; Sequencer</a>	PDF (Acrobat Reader)	1.5 MB
<a href="#">Data sheet Power Sink SM3300</a>	PDF (Acrobat Reader)	649.2 KB
<a href="#">Driver Serial Interface Module</a>	Software	6.8 MB
<a href="#">Application note Safe Operation Power Supply</a>	PDF (Acrobat Reader)	102.1 KB
<a href="#">Application note Wire Connectors ES150-Series</a>	PDF (Acrobat Reader)	221.6 KB

fig 7 - 2 - Via the web interface the downloaded firmware package can be uploaded to the unit.

The screenshot shows the web interface of the SM3300 power supply. The top panel displays real-time status: 15.00 V (CV), 0.0 A, and system metrics like 27°C and 0 rpm. Below this is a control panel with 'Voltage: 15', 'Current', and 'Output: On/Off' buttons. The main area is titled 'Update firmware' and shows a file selection process where 'Bladeren\_ SM3300\_H0\_P0114.bin' is chosen. A password field and a 'Start update' button are present. A note states: 'Please the keep unit powered during the update process.' At the bottom, a 'System information' section lists: Unit type: SM18-220, Serial number: 000010073528, Manufacturer: Delta Elektronika B.V., and Software version: SM3300\_H0\_P0114.

fig 7 - 3 - Via the web interface the downloaded firmware package can be uploaded to the unit.

## 8 REMOTE PROGRAMMING

### 8.1 SOURCE SETTINGS

- Via the front menu, the source can be set to the required programming input via: Menu -> Configuration -> Source.
- The possible settings for V-settings, I-settings and P-settings are: front encoders, ethernet, web interface, sequencer or an optional interface in rear slot1, 2, 3 or 4.
- It is possible to have different sources for the settings for example V-settings via 'web' and I-settings via 'front'.

### 8.2 WEB INTERFACE

- It is advised to use the web browsers Mozilla Firefox or Google Chrome.
- The web interface is available 40 seconds after start up of the unit.
- Set the programming source for voltage and/or current to 'web' via the front menu.
- The below menu items are available in the web interface:

#### 8.2.1 CONSOLE

##### FRONTPANEL

- Possible settings via the console:
  - voltage and current
  - output On/Off
- Possible monitoring via the console:
  - actual and set values of voltage and current
  - output setting (on/off)
  - status icons, for example DC-fail
  - type of unit and serial number
  - on time of the unit
  - system temperature and fan speed
  - input voltage
- See fig. 8 - 1 for the console lay-out.

##### SEQUENCER

- Possible to select sequences from the unit memory.
- Running, Pausing and Stopping of sequences.
- Trigger sequence
- Running in Single Step mode.
- See fig. 8 - 2 for the console lay-out.

##### MASTER / SLAVE

- Only available on the Master unit.
- Overview of the entire system.
- Shows the most important icons.
- Links to the front panels of Slave units when the Slave(s) are connected to the same LAN. (Click ID#)
- See fig. 8 - 3 for the console lay-out.

#### 8.2.2 CONFIGURATION

##### GENERAL

###### FRONTPANEL

- Front user interface language.
- Front unlock key protected (Enabling will lock Frontpanel).
- Backlight intensity when active.
- Backlight intensity when no user interaction.
- Timeout for backlight dimmer.
- LCD contrast.

###### DEFAULTS

- Default voltage setting and value after power cycle.
- Default current setting and value after power cycle.
- Default output state after power cycle.

###### SOURCES

- Set the program source for voltage control.
- Set the program source for current control.

###### POWER SINK



fig 8 - 1  
Front console for setting of the output and monitoring various parameters.



fig 8 - 2  
Sequencer console for selecting and controlling sequences.

- Enable / disable Power Sink.
- Enable / disable Power Sink when Remote ShutDown status is high.
- Enable / disable Power Sink when Interlock status is high.
- Enable / disable Power Sink when the Output is Off.

#### NETWORK

- DHCP enabled / disabled.
- IP Version.
- Network IP address.
- Network Subnet mask.
- Network Gateway address.
- Network interface MAC address.

### INTERFACES (Slot1, 2, 3 and 4)

#### ISOLATED ANALOG

- Voltage levels on analog programming and monitoring for output voltage and current.
- Level of Status signals ACF, DCF, PSOL, LIMIT, RSD, OT and CC.

#### SERIAL & USB

- Select BUS-type: USB, Differential or RS232.
- Device channel nr.
- Baudrate, Databits, Stopbits, Parity bits.
- Slewrate, Termination, Simplex/Duplex.

#### DIGITAL I/O

- Level of digital inputs A...H (High / Low).
- Level of digital outputs A...H (High / Low).

#### ISOLATED CONTACTS

- Status of the relay contact 1...4 (On / Off).
- Level of the Interlock input (High / Low).
- Level of the Enable input (High / Low).

#### MASTER / SLAVE

- Enable or disable master / slave mode.
- Select Master or Slave.
- Number of units in parallel or series.

#### SEQUENCES

- Upload sequences into the unit's volatile memory.
- Synchronize memory to copy sequences from the volatile to the non-volatile memory.
- After switching off the unit, the sequences remain on the power supply.
- Monitor and make settings:
  - View sequencer name
  - View if it is loaded as active sequencer
  - View if it has been built
  - Mark for Non-Volatile
  - Set start/stop conditions
  - Set if to restore or retain output state and values after it is terminated
  - Mark for deletion
- See paragraph 4 of this chapter for more information about sequencer programming.

### 8.2.3 ADMINISTRATION

#### FIRMWARE

- Here a new firmware package can be uploaded.

#### INFO

- System information
  - Unit.
  - Serial number.
  - Manufacturer.
  - Software version.
  - Custom mode
  - Internal error.
- Highlight button
  - Display on front will blink for about 2 seconds.
  - Buzzer on front is on for about 2 seconds.

#### PASSWORD

- Change the password to block the unit.

- The default password is "depower".
- Passwords are not case sensitive.
- In case of a forgotten password see next chapter Trouble Shooting.

8.2.4 DOCUMENTATION

- Unit documentation in PDF-format available:
  - Safety instructions.
  - Unit operation and installation manual.
  - Interfaces operation and installation manual.
  - Ethernet & Sequencer programming manual.

8.3 ETHERNET

- The ETH interface is available 40s after start up of the unit.
- Connect the unit to the network via the LAN-connector at the rear side, see fig. 8 - 3.
- Download the programming manual for Ethernet & Sequencer via the web interface or via [www.delta-elektronika.nl](http://www.delta-elektronika.nl).
- Set the programming source for voltage, current and/or power to 'eth' via the front menu or the web interface.

8.4 SEQUENCER

- Download the programming manual for Ethernet & Sequencer via the web interface or via [www.delta-elektronika.nl](http://www.delta-elektronika.nl).
- Define a sequence using a basic text editor, for example Notepad. Save as "filename.seq". An example is shown in fig. 8 - 4 and fig. 8 - 5.
- Upload the sequence to the unit via the web interface or via Eth programming commands.
- Set the programming source for voltage, current and/or power to 'seq' via the front menu, the web interface or Eth commands.
- Start/Stop the sequence via the web interface, Eth commands or a hardware trigger via the Digital I/O interface.
- **Note:** copy the uploaded sequences into the non-volatile memory before switching off the unit. Standard they are uploaded in the volatile memory and are lost after switching off the mains.

8.5 OPTIONAL INTERFACES

- Set the programming source for voltage and/or current to 'slot1...4' via the front menu, the web interface or Eth commands.
- The following interfaces can be plugged in the slots at the rear panel of the unit. There is room to insert a total of 4 interfaces (see fig. 8 - 6 ... 11).

8.5.1 ISOLATED ANALOG PROGRAMMING

- With this interface it is possible to program the CV- and CC-settings using a 0 - 5V or 0 - 10V voltage source.
- The CV- and CC-monitor signals can be measured with a volt meter (0 - 5V or 0.10V). Also available are the 5V logic status signals, Remote ShutDown (RSD = 5V), an auxiliary voltage (+12V) and a reference of 5.1V.
- Because the interface is isolated from the power output, earth loops between the programming source and the power supply are prevented.
- All connections are pin compatible with other Delta Elektronika power supplies such as ES150, SM800, SM1500, SM6000 etc.
- **Note1:** analog interface can NOT be inserted in slot1.
- **Note2:** maximum 1 analog interface possible per unit.
- See datasheet and manual of the INT MOD ANA for more information.

8.5.2 SERIAL & USB PROGRAMMING

- The protocols RS232, RS422, RS485 and USB (Virtual COM) are supported by this interface.
- With this interface it is possible to program the CV- and CC-settings, to read the CV- and CC-monitor values and the internal status signals. See datasheet and manual of the INT MOD SER for more information.

8.5.3 DIGITAL I/O

- This interface provides 8 opto-isolated logic inputs and 8



fig 8 - 3  
The location of the LAN-connector and the available interface slots at the rear panel.

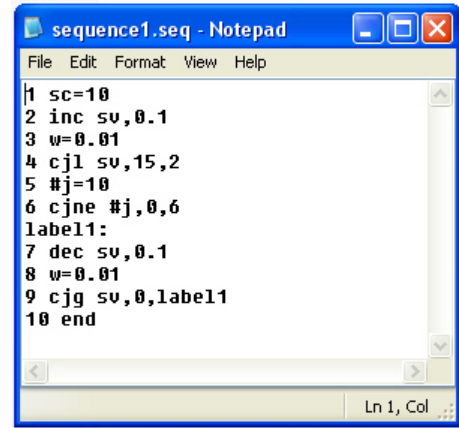

fig 8 - 4  
Example of a small sequence to ramp up the output to 15V and then back to 0V.

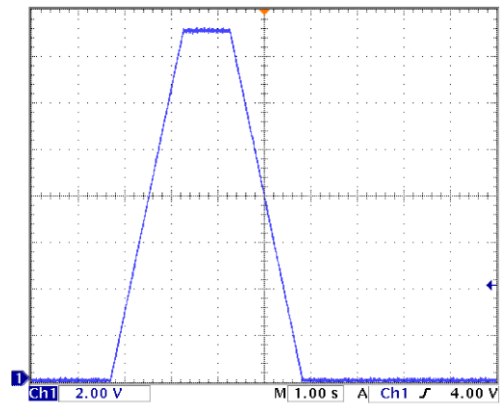

fig 8 - 5  
Output voltage as result of the above example..



fig 8 - 6  
Isolated Analog interface

opto-isolated logic open drain outputs.

- All in- and outputs have a common zero.
- See datasheet and manual of the INT MOD DIG for more information.

8.5.4 ISOLATED CONTACTS

- On this interface, there are 4 floating relay contacts available that can be controlled by Ethernet commands.
- This can be used to trigger an external safety alarm or to interact in automated processes.
- Floating Interlock connector (standard Interlock is at the level of Safety Earth).
- Floating Enable input to switch the output On/Off (24Vdc).
- See datasheet and manual of the INT MOD CON for more information.

Note: the floating relay contacts cannot be controlled by the sequencer.

8.5.5 SIMULATION

- With this interface it is possible to perform several simulations.
- One of these simulation modes is photovoltaic simulation based upon user variables.
- Other simulation modes are internal resistance, leadless sensing and fold current simulation.
- All modes are easy configurable through the web interface.
- **Note1:** simulation interface can NOT be inserted in slot1.
- **Note2:** maximum 1 simulation interface possible per unit.
- **Note3:** this interface cannot be combined with a master slave interface.
- See datasheet and manual of the IND MOD SIM for more information.

8.5.6 MASTER / SLAVE CONTROL

- The resulting combination behaves like one power supply and can be manually controlled or programmed on the master.
- Mixed parallel - series operation is also possible.
- **Note1:** maximum 1 master slave interface possible per unit.
- **Note2:** this interface cannot be combined with a simulation interface.
- See datasheet and manual of the IND MOD M/S for more information.



fig 8 - 7  
Serial & USB Programming Module.



fig 8 - 8  
Digital I/O Module.



fig 8 - 9  
Isolated Contacts



fig 8 - 10  
Simulation interface



fig 8 - 11  
Master Slave interface M/S.  
Note: the M/S can only be used in sm3300,  
the INT MOD M/S-2 only in the SM15K



## 9 TROUBLE SHOOTING

### 9.1 GENERAL

- If you have a question about the unit, please contact our engineers using the address Support@Delta-Elektronika.nl.
- In case the unit is defect, please first fill out the RMA-form before sending the unit to us. Adding a detailed fault description will help us to repair the unit as soon as possible. Do not try to repair the unit yourself.
- On our website the RMA-form can be found under 'Support'.

### 9.2 NO DC OUTPUT

- Check the output is switched ON: the text 'ON/off' must be visible on the right side of the display.
- If the text is 'on/OFF', press the button next to this text to switch it ON if needed.
- Check the unit is not in LOCK mode: the text 'Lock' must be visible on the right side of the display.  
If the text is 'Unlock', press the button next to this text for a few seconds to unlock the unit, see fig. 9 - 1.
- First set the unit in local operation (or so-called manual operation): press and hold the ON/off button for 4 seconds. On the second line of the display, before both the set values the text 'front' will be seen, now press the button next to the text on/OFF to switch on the output.
- Check the connections on the SENSE BLOCK (at rear panel). For local sensing, there should be a link between + and S+ and between – and S– (see fig. 9 - 2).  
For remote sensing, the wires from S+ and S- should be connected to respectively the + and - terminals on the load.
- Check there is a link between pin 1 and pin 3 of the Interlock connector.
- Check the settings for CV- and CC-limit are set to a value greater than 0.  
Go to Menu -> Protection -> Limits.  
Here set Voltage and Current limits.
- Turn both the CV and CC encoders a few turns clockwise. Now a voltage should be present on the output.

### 9.3 PROGRAMMING DOES NOT WORK OK

- First make sure the unit works ok in local mode, see previous paragraph.
- If this is okay, check the unit is in Remote mode.
- Go to Menu -> Configuration -> Source.
- Here set the Vsettings and Isettings to the required programming source, either 'eth', 'web', 'slot1', 'slot2', 'slot3' or 'slot4'.
- For example, when programming via Ethernet, on the second line of the display, before both the set values the text 'eth' must be seen.
- It is also possible to only have only one of the settings in remote mode, and have the other setting in local mode.
- Enter a command to program both the CV and CC setting to a value greater than 0.
- Now a voltage should be present on the output.

### 9.4 MASTER / SLAVE PARALLEL PROBLEMS

- Check the voltage drop of the wiring between the master and the slaves is < 10 mV.
- Check the wiring has a low inductance.
- See interface manual for more trouble shooting.

### 9.5 OUTPUT VOLTAGE IS HIGHER THAN SET VALUE

- Check connections on SENSE BLOCK (on rear panel), For normal operation there should be a link between + and S+ and between – and S– (see also fig. 9 - 2).
- When remote sensing is used, check the wires of the sensing.

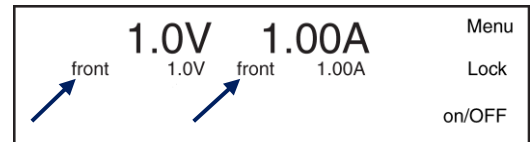

fig 9 - 1  
At the right side, the texts must be 'Lock' and 'ON/off'.



fig 9 - 2  
For normal operation links should be connected between S+ and +, and between S– and –.

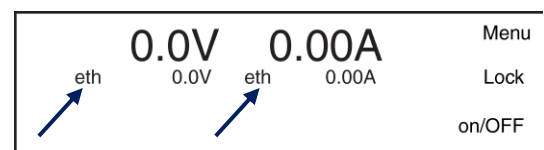

fig 9 - 3  
For Ethernet programming, the text 'eth' must be seen before the setting(s) that is/are in 'remote mode'.

### 9.6 OT indicator blinks

- The temperature of the internal heat sink is too high, the output has been shutdown to avoid overheating.
- Check if the cooling fan is running.
- Check if the air temperature of the air inlet (left) is below 50 °C and the airflow is not obstructed.

### 9.7 ACF indicator on

- The input voltage is too low or was intermittent because of a bad connection. Disconnect the mains, wait a few minutes and try again.
- If the input voltage is within the specified range, there must be an internal error. Send unit for repair, see paragraph 1) of this chapter.

### 9.8 DCF indicator on

- The output voltage is 5% below/above the set voltage. This automatically happens when the unit is in CC-mode.
- If the output voltage is within the set value, there must be an internal error. Send unit for repair, see paragraph 1) of this chapter.

### 9.9 PSOL indicator on

- The Power Sink is in overload or the temperature of the Power Sink is too high. See datasheet of the Power Sink for further details.

### 9.10 Internal Error indicator on

- This indicator is active if there is an internal error in the unit, or when an interface is not correctly configured. Verify the "System information" page of the web interface. Or contact support.

### 9.11 Forgotten password, access key or network settings

- To reset the front panel access key, the password and the network settings to their default values, press the reset button at the rear panel of the unit.
- A bent paperclip can be used to press the internal micro push button (see fig. 9-9).  
A soft sensible click can be noticed. Press and hold the button for at least 2 seconds in order to activate the default restoring mechanism.

### 9.12 Other

- If the problem is not described in the above paragraphs, please see paragraph 1 of this chapter on how to contact our support department or send the unit for repair.



fig 9 - 4

If the OT-icon is shown on the display, the unit has run hot and the DC power terminals are shut down.



fig 9 - 5

If the ACF-icon is shown on the display, the unit has not enough AC input power and the DC power terminals are shut down.



fig 9 - 6

If the DCF-icon is shown on the display, the voltage at the DC power terminals is 5% below/above the set voltage.



fig 9 - 7

If the PSOL-icon is shown on the display, the power sink has reached the power limit.



fig 9 - 8

If the Internal Error-icon is shown on the display, the DC-power output of the unit will shut down.

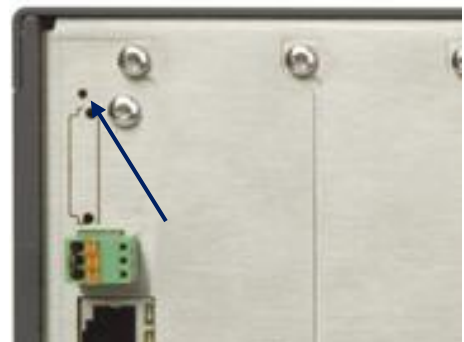

fig 9 - 9

Location of the reset button.



## 10 MAINTENANCE & CALIBRATION

### 10.1 GENERAL

- The SM-series power supplies do not need any maintenance or calibration. However, care must be taken that the cooling unit is not obstructed.

### 10.2 COOLING FAN

- The internal construction of the power supply is such that no dust will reach the sensitive control circuitry, only the heat sink in a tunnel will be cooled by forced air (see fig. 10 - 1)
- The built up of dust on the impeller of the fan and the heat sink fins depends on the environment. It is advised to inspect the fans and heat sinks regularly.
- Since the used fan type has an over-capacity, dust will not present a problem very quickly.
- The thermal protection will shutdown the output in case of overheating, so no damage will be done to the power supply.

### 10.3 GALVANIC INDUSTRY

- For using the power supplies in the galvanic industry it is strongly recommended to take precautions against an aggressive environment.
- An aggressive environment with acid, salt, etc. can harm the electronic components. Sometimes even the copper tracks on the printed circuit boards dissolve.
- To avoid problems, the power supplies should be mounted in a relatively clean room, in a cabinet receiving clean air with over pressure, or a cabinet with a heat exchanger.

### 10.4 CALIBRATION

- The power supplies are factory calibrated and normally need no further calibration.
- After installation of a new or different interface, no calibration is needed.
- Only in special situations, for example after repairing a unit, calibration can be necessary.
- The SM3300 units can only be calibrated by software.
- Inside the unit, there are no positions with calibration components such as trimmers or CR-resistors.
- The software calibration is performed by connecting the unit to a TCP/IP network using the LAN connector at the rear panel.
- Download the programming manual for Ethernet & Sequencer via the web interface or via [www.DeltaPowerSupplies.com](http://www.DeltaPowerSupplies.com).

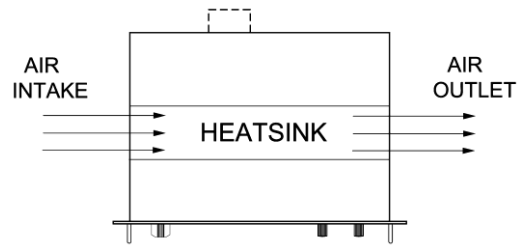

fig 10 -1

The fan is located at the left side and blows through the tunnel.



## 11 EU Declaration of Conformity – SM3300-series



We

Delta Elektronika  
Vissersdijk 4  
4301 ND ZIERIKZEE  
The Netherlands

Declare under sole responsibility that the following Power Supplies:

**SM18-220**  
**SM66-AR-110**  
**SM100-AR-75**  
**SM330-AR-22**  
**SM660-AR-11**

Meet the intent of Directives

2014/30/EU Electromagnetic Compatibility (EMC)  
2014/35/EU Low Voltage Directive (LVD)  
2011/65/EU Reduction of Hazardous Substances (RoHS2)

Compliance was demonstrated to the following specification as listed in the official Journal of the European Union:

<b>EN 61326-1:2013</b>	<b>EMC requirements for electrical equipment for measurement, control and laboratory use</b>
<b>EN 61010-1:2010</b>	<b>Safety requirements for electrical equipment for measurement, control and laboratory use</b>
<b>EN IEC 63000:2018</b>	<b>Assessment of electrical and electronic products with respect to RoHS</b>

J. Koopman  
Managing director,  
Zierikzee, February 2025